

PIC3d[©]

Logiciel CFAO pour l'emballage créatif
par treeDIM - 2019

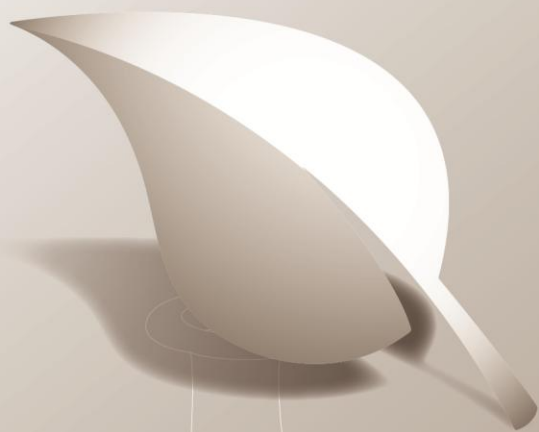

3D

USER GUIDE
// PICADOR 3D

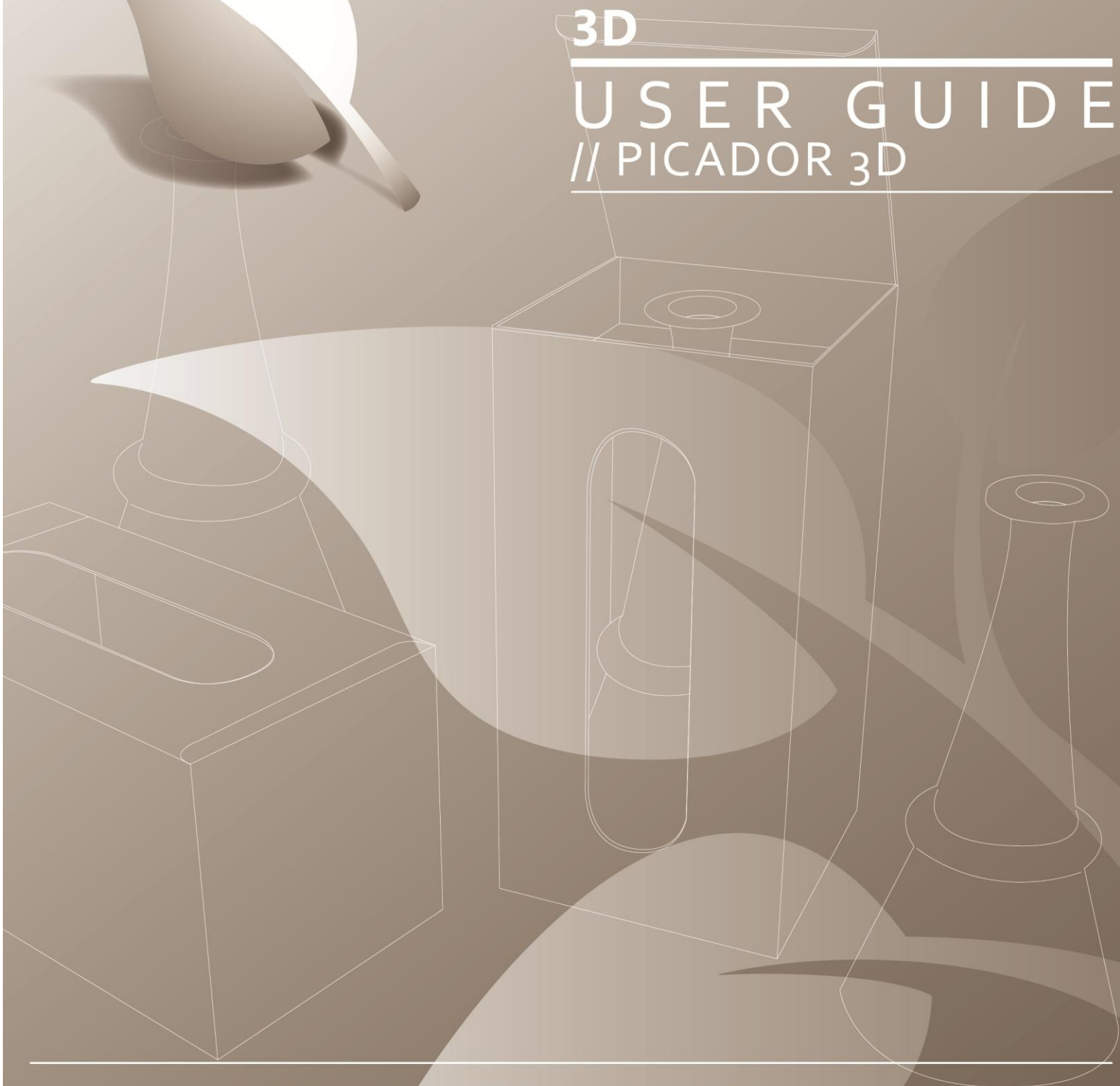

Table of contents

WARNING	4
Read before using.	4
Welcome	5
Foreword.....	5
Documentation of PICADOR®	5
Getting ready for technical support	6
Presentation & Ergonomy	7
Description.....	7
Mouse conventions	7
Creation of a folded element	8
Prepare your 2D drawing	8
Automatic 3D folding	10
3D Navigation	12
3D showing	12
3D animation of folding.....	13
Angles and folding steps	14
Thickness and axis of folding.....	16
Relative position of fold axis : from 0 to 10	16
Material, texture, image.....	17
Material color	17
Insert Texture / Image.....	18
Local landmark.....	20
Others 3D objects	21
Create a 3D object by revolution	21
Create a 3D object by extrusion.....	22
Import a 3D object.....	23
Create a composit 3D object	24
Create a repeated 3D object.....	26
3D ASSEMBLY	27



- Principles of 3D assembly..... 27
- Adding types of objects in the 3D view..... 27
- Transferency of solids between 2 documents 28
- Global landmark –local landmark..... 29
- Moving the objects in the 3D assembly : 30
- Displacement point-to-point..... 30
- ANIMATION 3D 31
 - Principles of 3D animation 31
 - Folding management in 3D animation 32
- Export 2D..... 33
 - Export a picture 33
 - Export to the clipboard 33
 - Obtaining a projected wireframed view (2D) 34
- Export 3D objects 35
 - Export a 3D pdf 35
 - Export a video capture 36
 - Export Collada .DAE et .FBX 37
 - Export .STL 38
 - Export virtual reality..... 39
- 3D INTERSECTION 40
 - Principles of 3D intersection..... 40
 - Intersection calculation example..... 41
- 3D dimension..... 42
 - 3D dimension creation 42
 - 3D dimensions editing..... 42

WARNING

Read before using.

- 1- The information contained in this document can be subject of modifications without any previous advice.
- 2- This document is given to the user with only aim to make easier the knowledge of the **Picador®** system, of which he acquired the rights of use.
- 3- **TreeDIM® - Picador®** declines any responsibility for any damage which can result from the information contained in this document.
- 4- The attention of the user is drawn to the fact that it is prohibited to him to reveal, or to facilitate the disclosure of this document, to copy or reproduce all or parts of the document, by any means or under any forms, to translate it in any other language, without express agreement of **TreeDIM®**, owner of **Picador®** software.

Welcome

Foreword

Welcome in **Picador**[®] under **Microsoft Windows** environment, CAD solution that brings you all the power and ergonomics of its graphic interface. Available on all Microsoft Windows platforms, **32 bits & 64bits (XP, Vista, 7, 8, 10...)**

Documentation of PICADOR[®]

This guide was written for the sake of simplicity and accuracy in the information presented. For each function, you will find a description and the operation step by step implementation. When that required it, we took care of examples to illustrate the details of the features of **Picador**[®].

Getting ready for technical support



If you need assistance, contact **Technical Support PICADOR**. Before calling, stay in front of your computer with your drawing to the screen and the user guide of PICADOR at hand. Be ready to provide the following information:

1. The exact information detailed in the message that appeared on your screen when the problem occurred.
2. A description of what happened and what you did at that time.
3. What was attempted to resolve the problem.

How to obtain technical support?

You can contact us by various means:

Phone: (+33) 01 41 42 19 36

Mail: support@picador.fr

Website: www.treedim.com
www.picador.fr

Presentation & Ergonomy

Description

PIC3d® is the folding module and assembly of 3D CAD/CAM software PICADOR®. It allows from a 2D drawing, to automatically interpret the cutting lines and folding, then allow the user to define the particular bend angles and the various folding steps. Picador3D also allows to assemble several pieces of a packaging or a POS, import 3D objects, animate objects together, to calculate the intersections between cutting folded objects and 3D objects.

Mouse conventions

The following table explains the basic terms associated with using the mouse.

To	Do this
Point or Aim	Move the mouse cursor on a face or an object
Click	Click the mouse left button and release it
Double-click	Quickly press twice the left mouse button and release it
Move	Press the left mouse button and keep it pressed while moving the mouse cursor. Then release it.
Right click	Click the right mouse button and release it.

Creation of a folded element

Prepare your 2D drawing

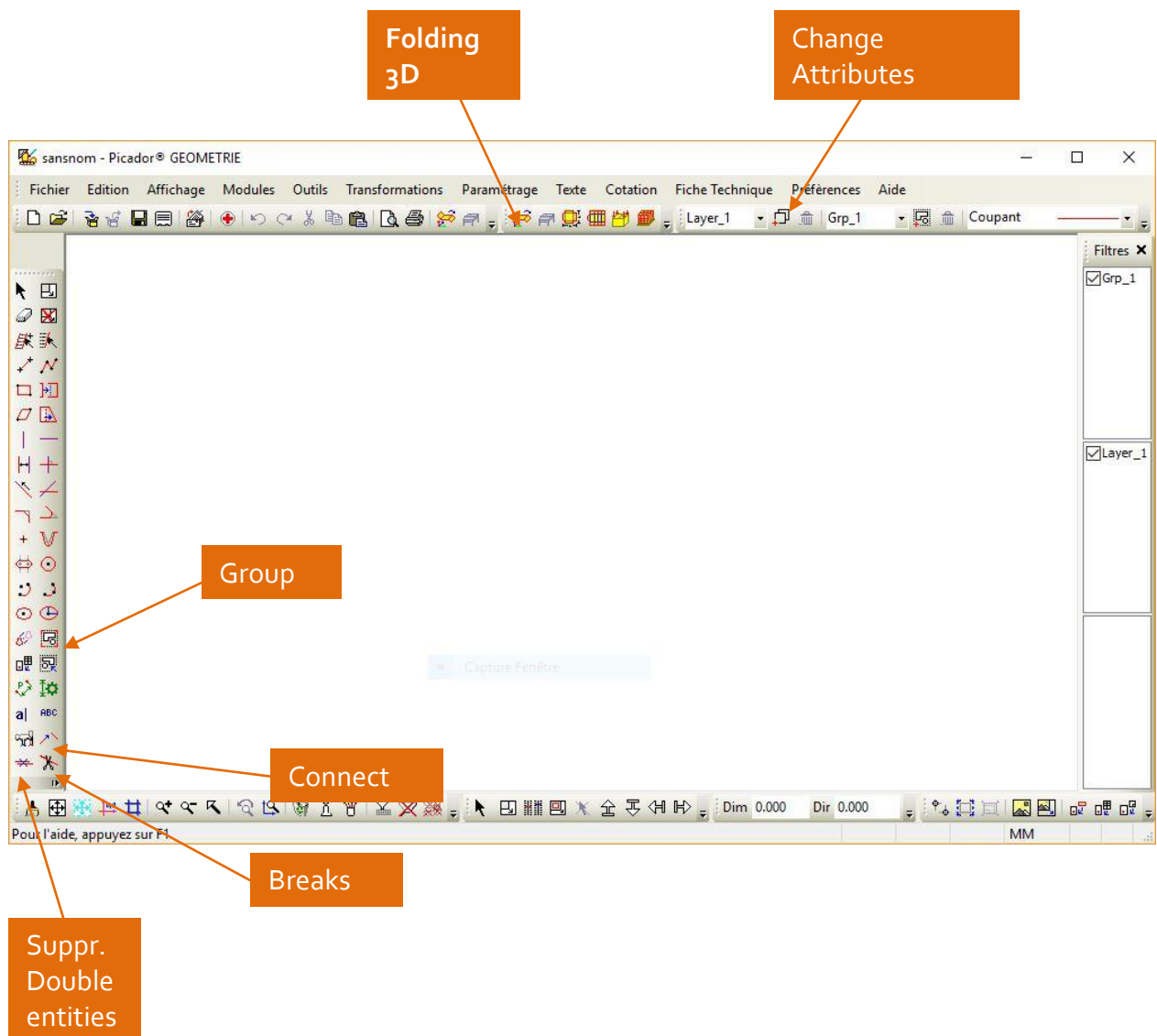

So that the automatic recognition of the faces to fold can be realized, it is necessary to do:

- Re-group the entities from the same piece in a same group :

Use the function  *Group Entities* to realize this operation. The toolbar groups allows you to control the different groups available in a document.

- Define the type of lines :



 Rainant

- The cutting edges will be in cut
- The bending parts must be in creasing lines, perfo, perfo-creasing or half-cut.
- Construction lines, axis, dimensions will be not interpreted.

- *Delete duplicate entities* 

- Choose the benchmark judiciously  : This point will then be the reference (absolute reference) of all the pieces (groups) contained in the drawing. A wise choice makes it easy to assemble 3D pieces.

If PICador 3D does not rebuild all the desired folding faces, you can also:

- Use the function « Breaks »  (Ctrl+A to select and then « Breaks »)
- Verify the entities connection. If a face is not closed, she can't be created. You can use the function *Connect*  to join together two close entities.

Then launch **PIC3D** thanks to the menu « 3D folding » or with the icon



Automatic 3D folding

Create a new foldable solid

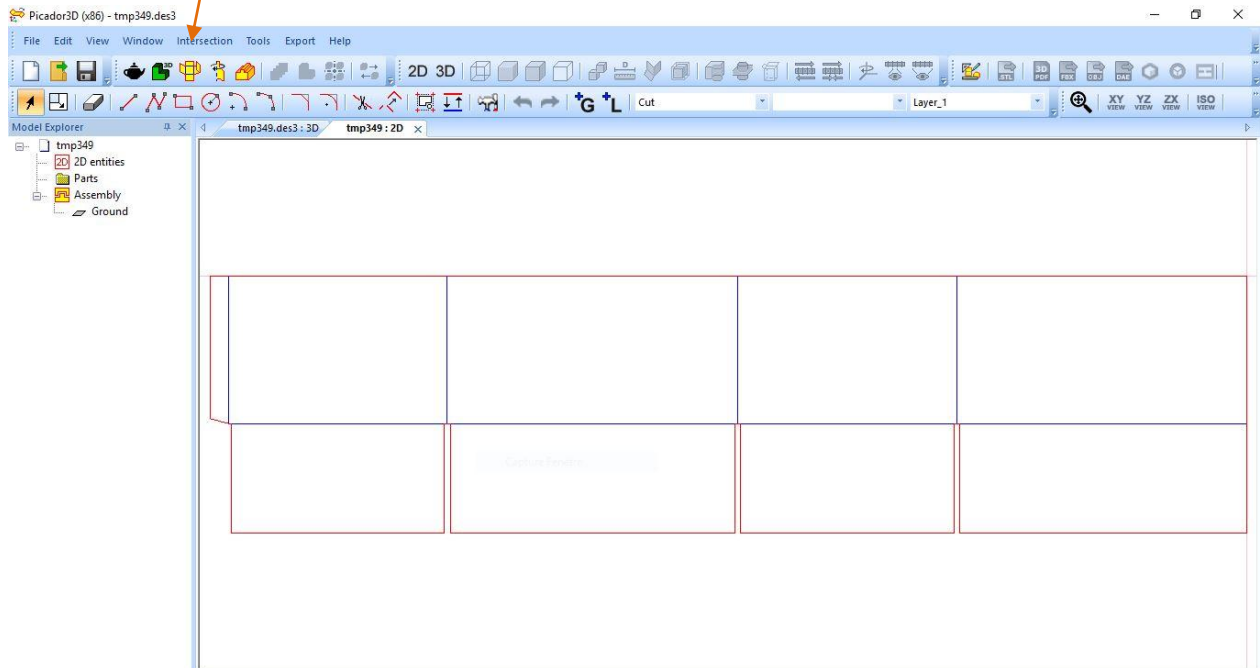

Once the 2D drawing is imported in PIC3D, you only need to use the function « *Create a new foldable solid* » thanks to the icon: 

The system show the following box :

Selectionner un groupe ΣΣ

Selectionner un groupe:	Grp 1 ▾	OK
Nom du type créé	Fold_1	Annuler
Distance de tolérance	0.3	
Angle de tolérance	1	

Give a name to the solid you will create

Then select the face to be used as the reference.

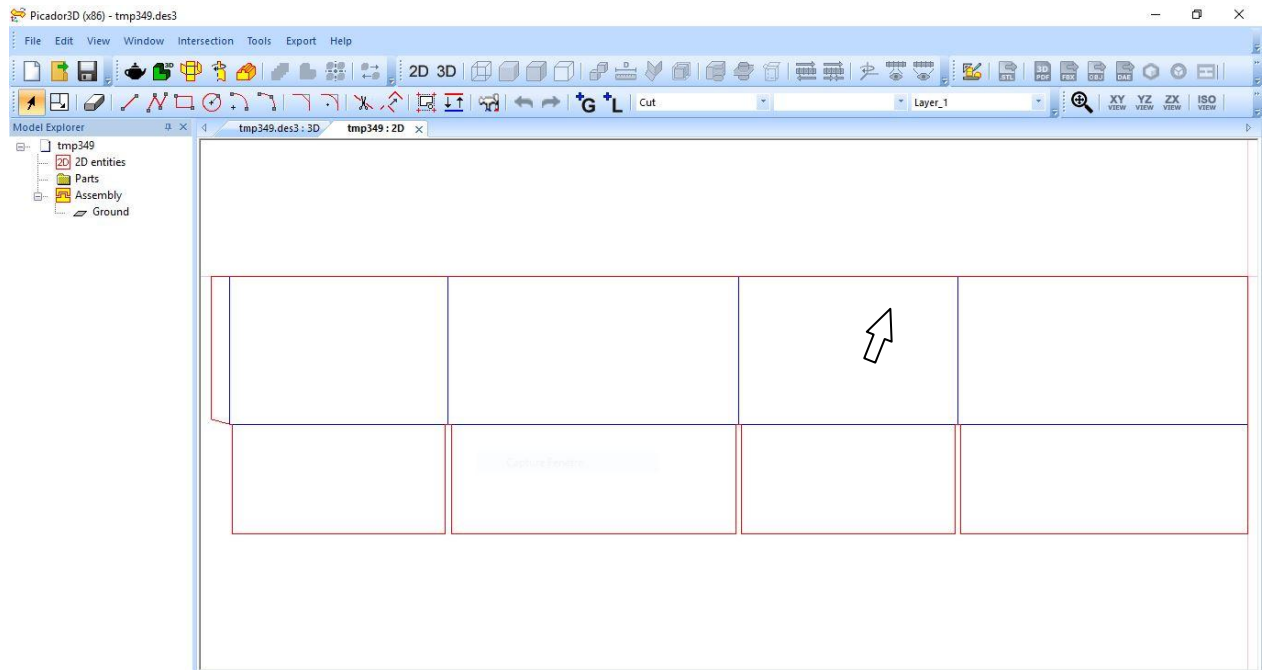

The selected face will define the reference face from which all other faces will bend at 90° by default.

3D Navigation

To move or rotate the 3D stage, you must point the cursor on the blue zone.

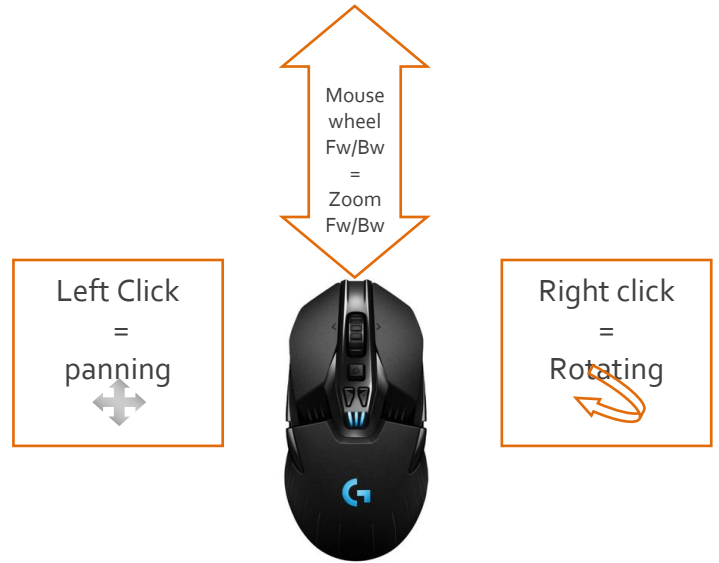

To perform a 3D rotation, the mouse cursor should be inside the blue circle

+ right click

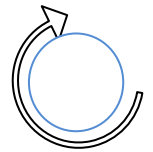

To perform a 2D rotation of the model, the mouse cursor should be outside the blue

+ right click



The view toolbar allows fitting the model in the 3D window  showing the model in the principal planes (xy, yz, zx), or an isometric view.

3D showing



Various showing modes are available :

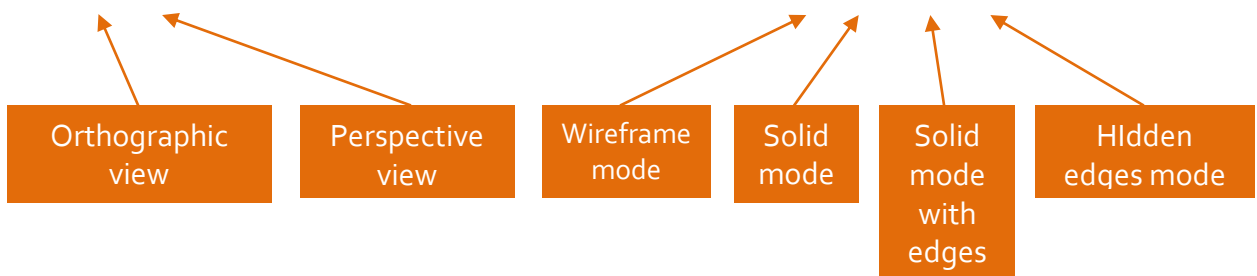

3D animation of folding

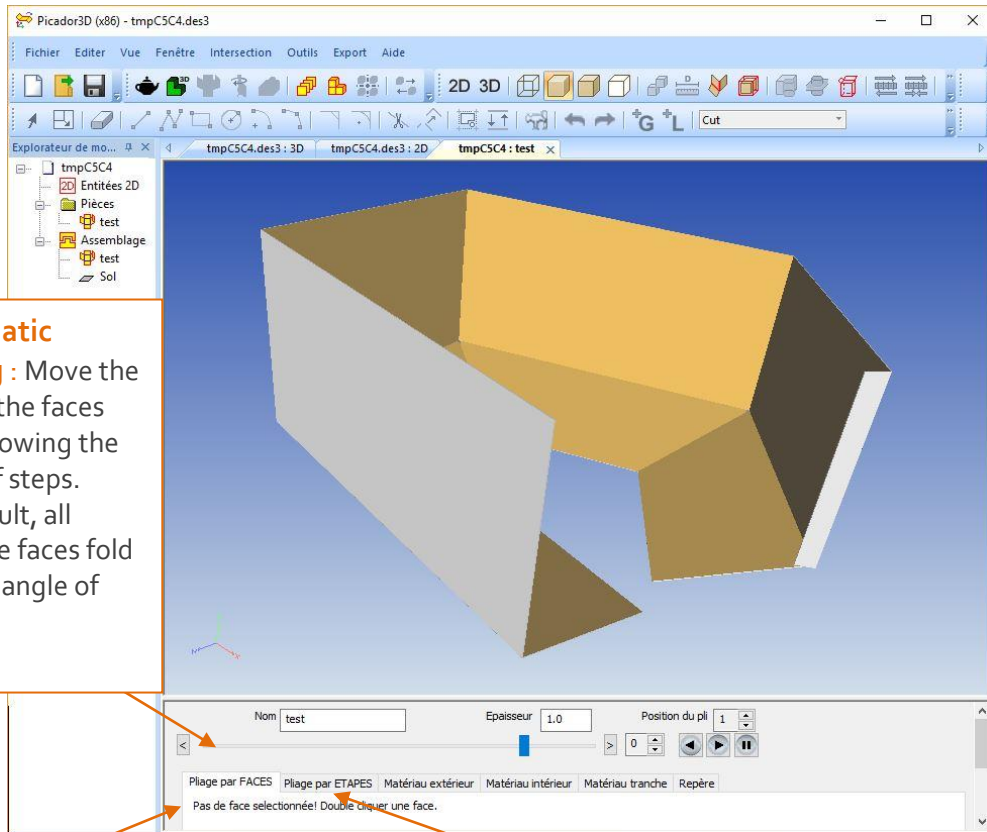

Automatic folding : Move the cursor: the faces fold following the order of steps. By default, all movable faces fold with an angle of 90°.

Interactive folding : Click successively on each face you want to fold or unfold and specify their respective angle at each step.

Paires étape/angle de la face sélectionnée(3)

Step #	Angle
0	0.0
1	45.0
2	90.0
3	45.0
4	0.0

Step-by-step folding :

Click successively on each face you want to fold or unfold and specify their respective angle at each step.

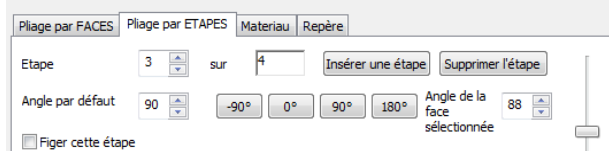

Angles and folding steps

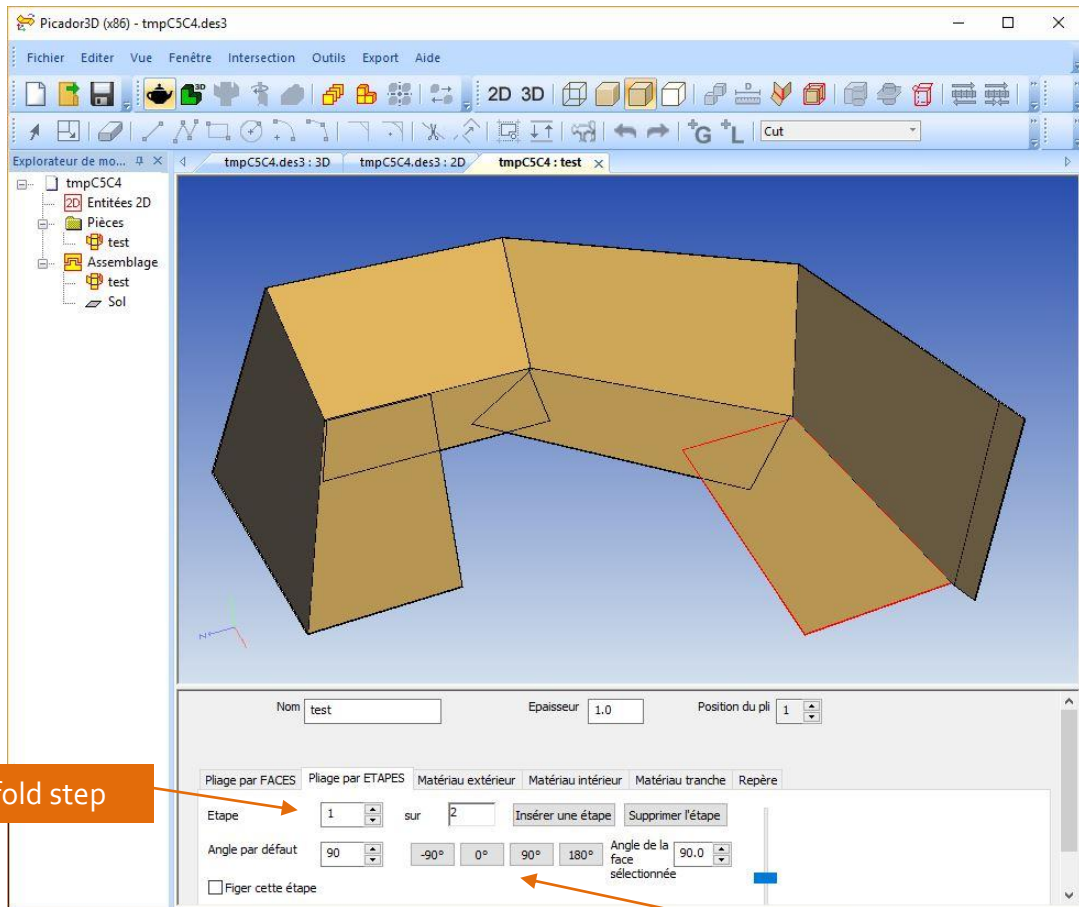

Define fold step

Fold angle

- Select the **Fold by step** tab.
- In the tab, select the folding step, and select each face that should be folded at that step.
- The spinner **"Angle of selected face"** allows specifying the angle to be given to the selected face.
- To check the kinematics of folding faces, select tab **"Definition by face"**.

- To insert a step after an active step, use the button **Insérer une étape**
- To control the folding faces cinematic, select the function **folding by faces**.

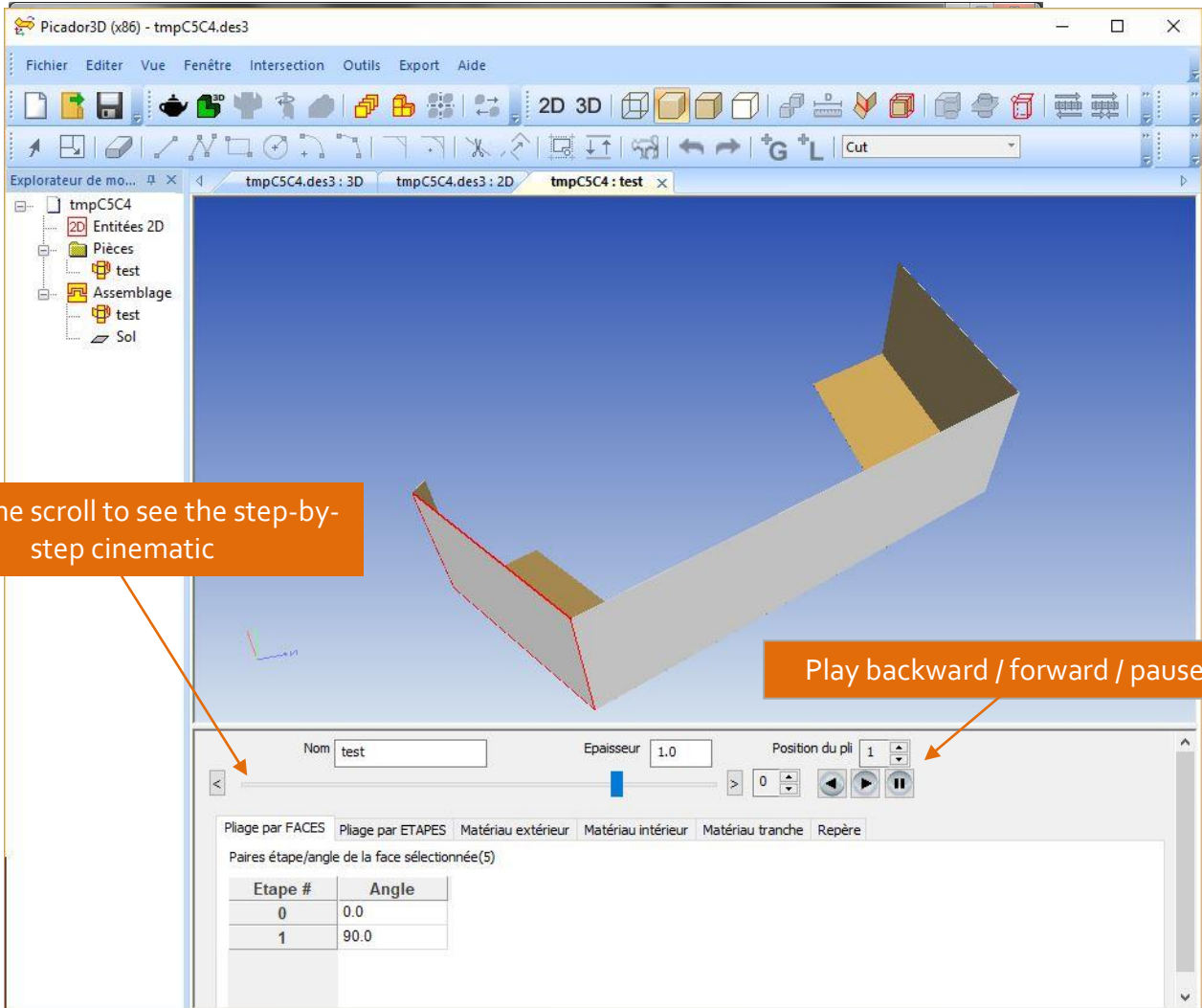

You can give a specific valor to the folding angle for each step, for a face previously selected.

Thickness and axis of folding

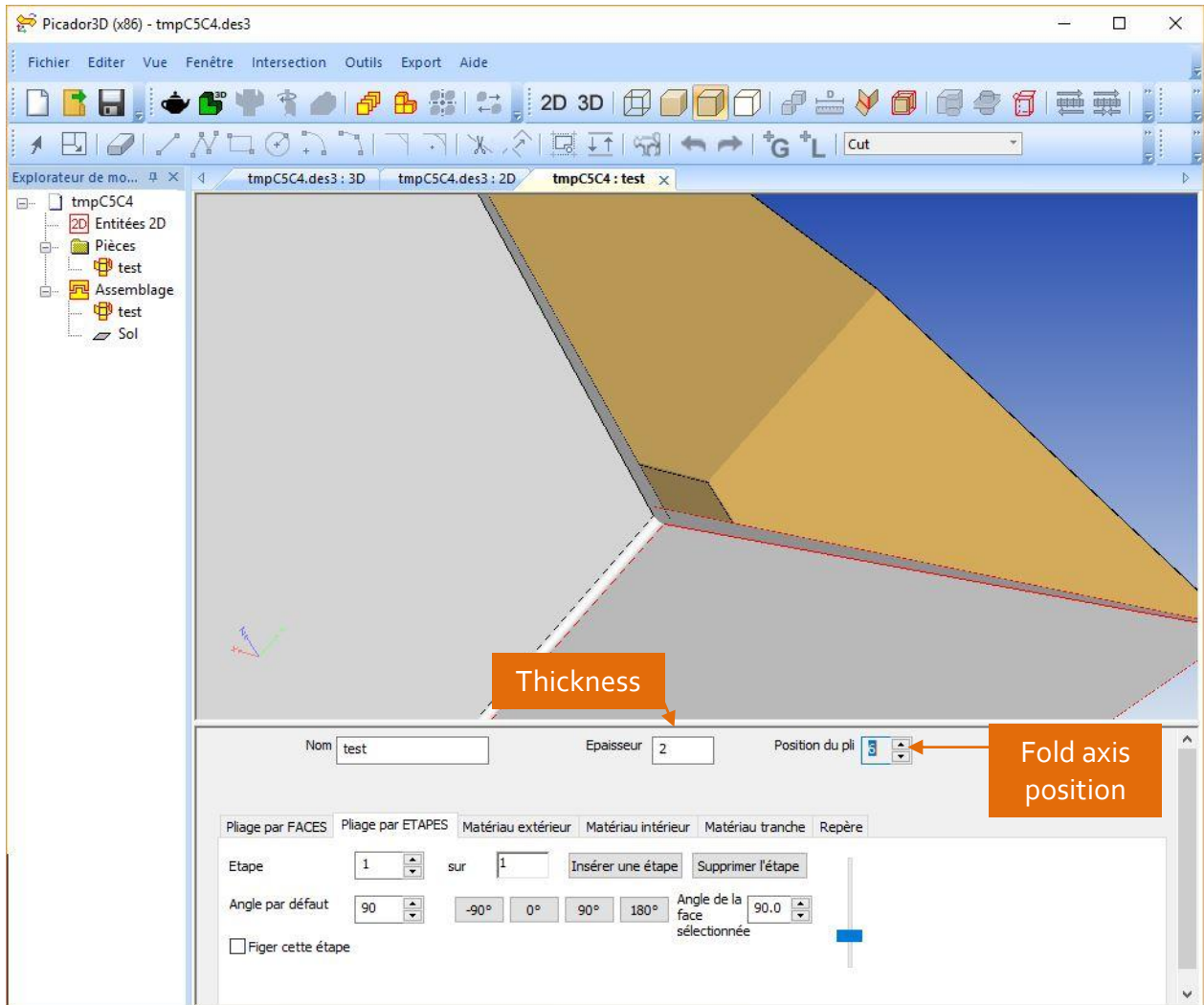

Relative position of fold axis : from 0 to 10

You can adjust the loss/gain value at the crease depending the material properties or the orientation that you wish to give to the fold.

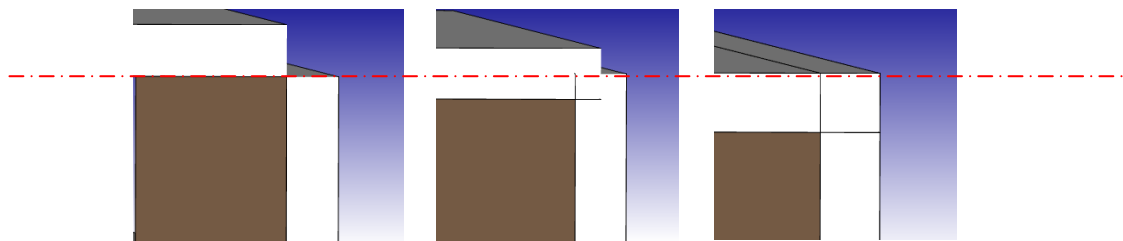

Fold position : 0
loss value at
crease = 0

Fold position : 5
loss value at
crease = thickness

Fold position : 10
loss value at
crease =
 $2 * \text{thickness}$

Material, texture, image

To define a texture or a material color, select the **Material** tab :

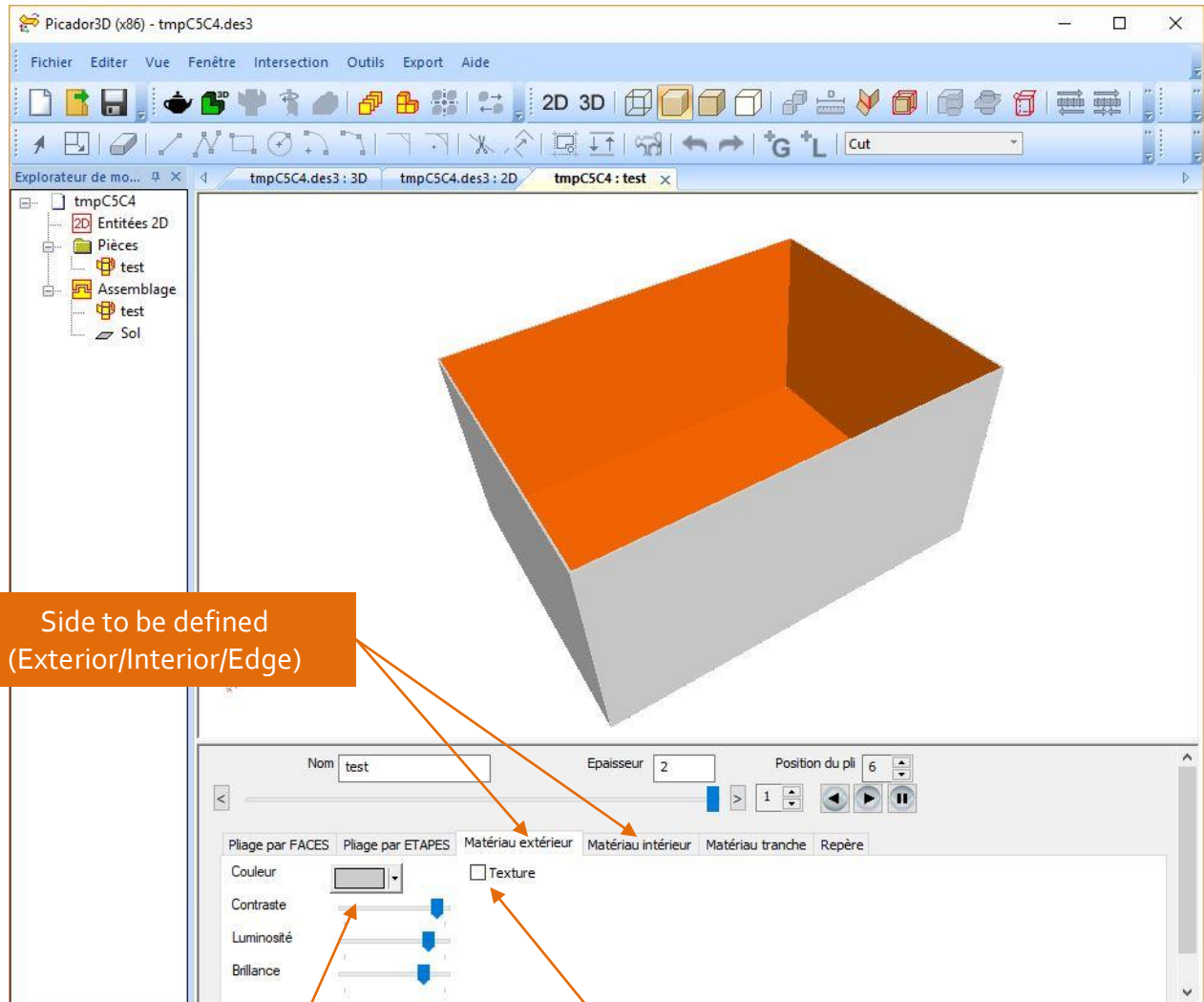

Side to be defined
(Exterior/Interior/Edge)

Modification of
material color and
light rendering

Modification of type of material: either
uniform color or texture

Material color

The color option allows to define a uniform color for the selected side (exterior/interior/edge). Material light parameters (ambient/diffuse/specular/reflectivity) allows to define the shades of color depending on the incidence of light.

Insert Texture / Image

The **Texture** option is used to position an image on the foldable solid.

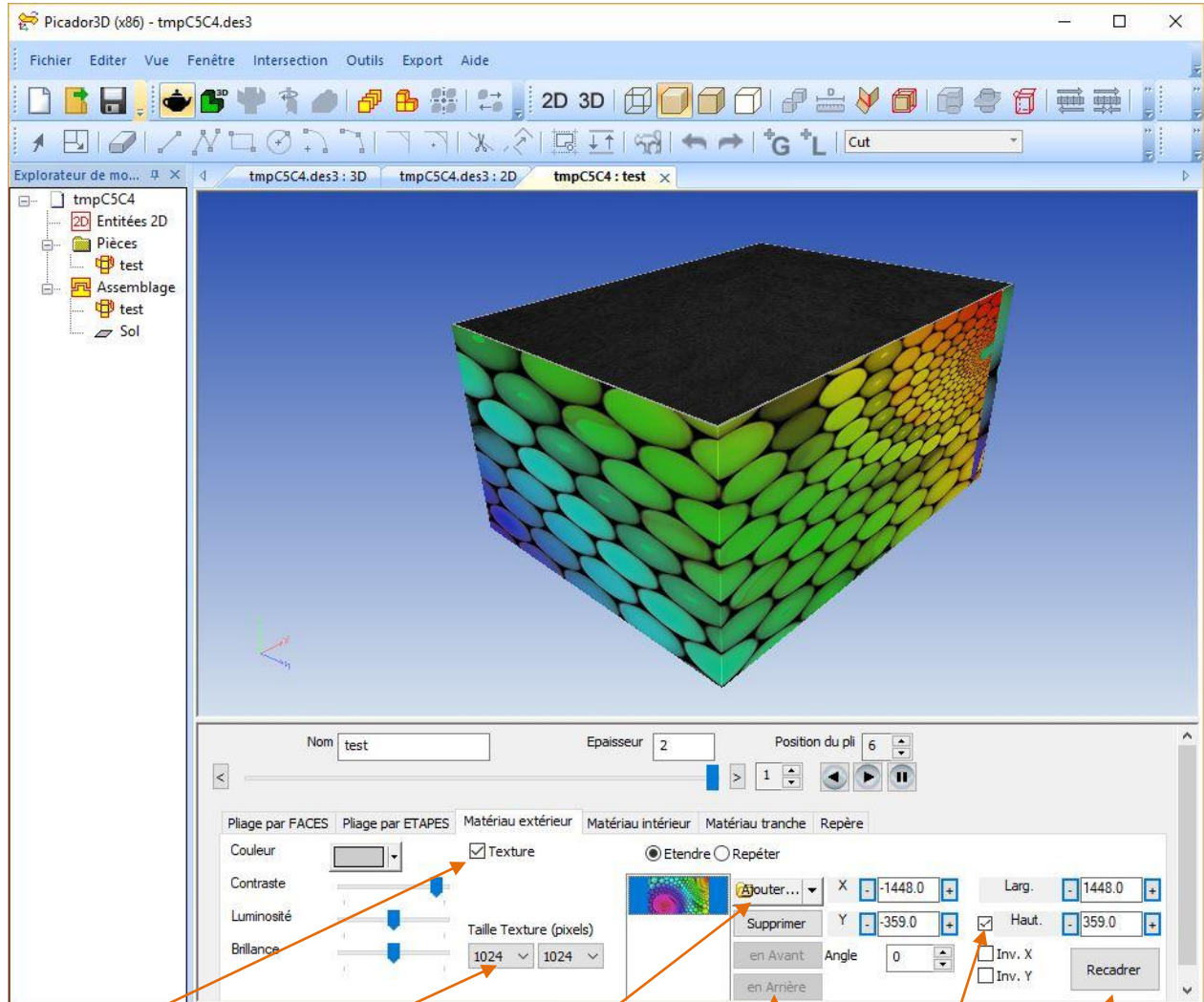

Texture / Image

Image resolution

Add a texture or an image

Determine the showing order

Uncheck to keep the original image aspect ratio: Prevent image distortion by keeping the same ratio between height and width.

Crop : Crop the image on the whole cutting area.
 x, y = position of bottom-left corner of image
width, height = width and height of the image.

The origin of the coordinate system is the same as in your 2D design.

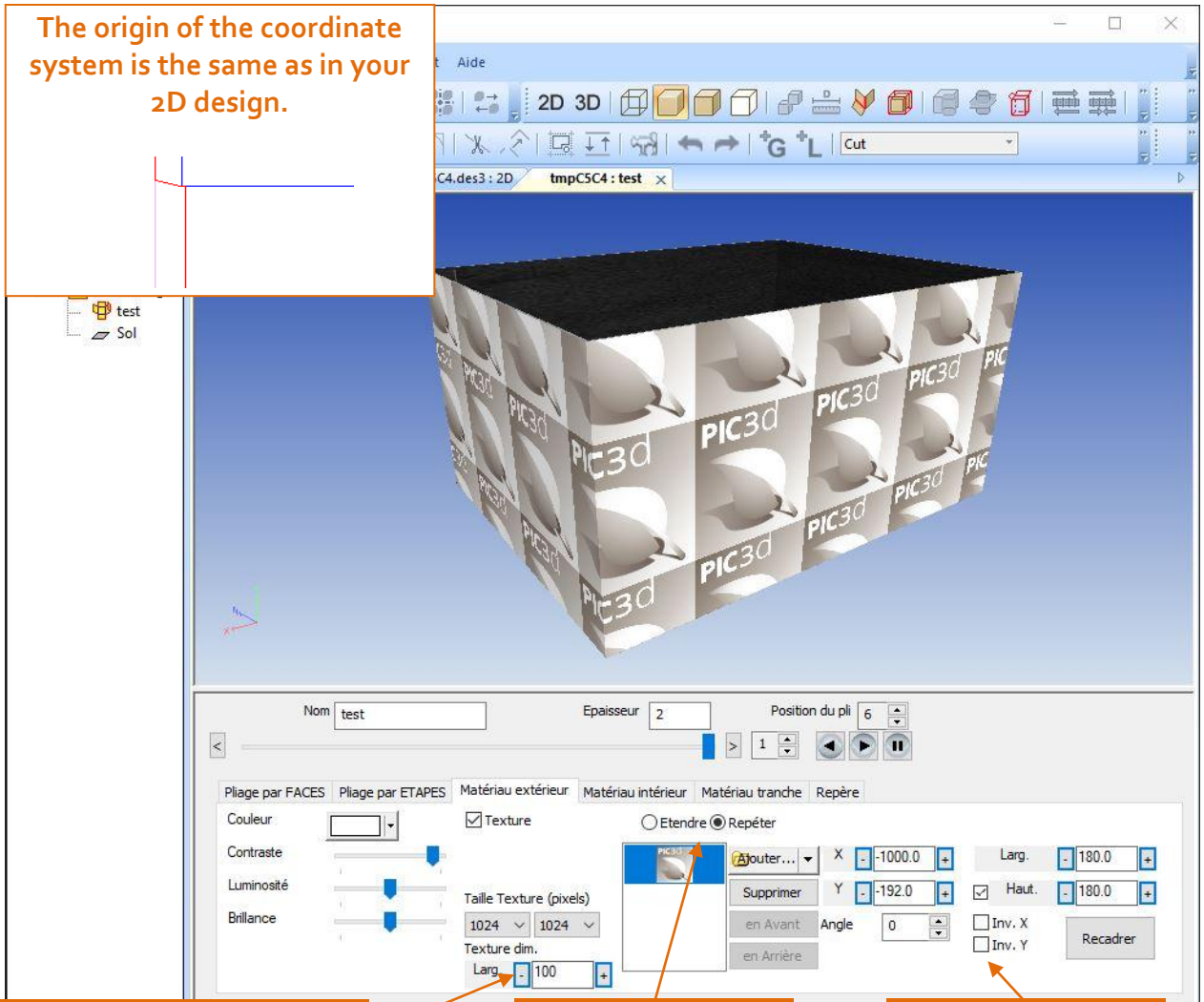
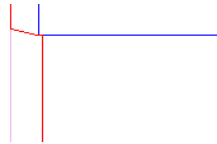

You can determinate the unit dimension of the image

Repeat : Allow to duplicate the image by horizontal and vertical repetition.

Inversion : Allow to invert the sense of the image/texture on the axis X or Y

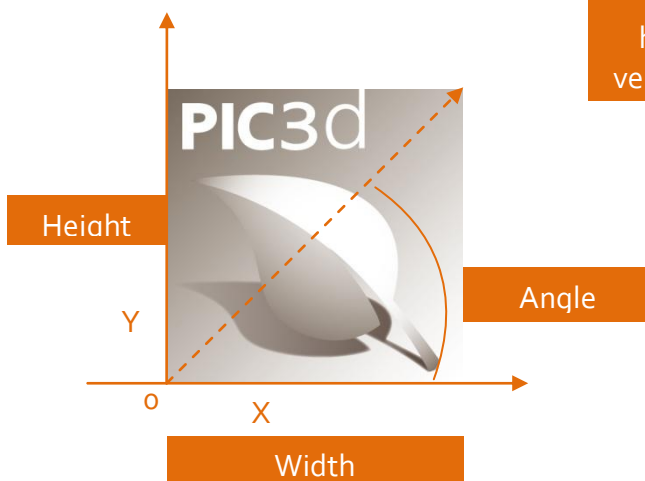

Local landmark

Each solid has a local reference (reference), which can be moved or rotated on the XYZ axes. The position of the repository determines the center of gravity of the solid for 3D manipulation.

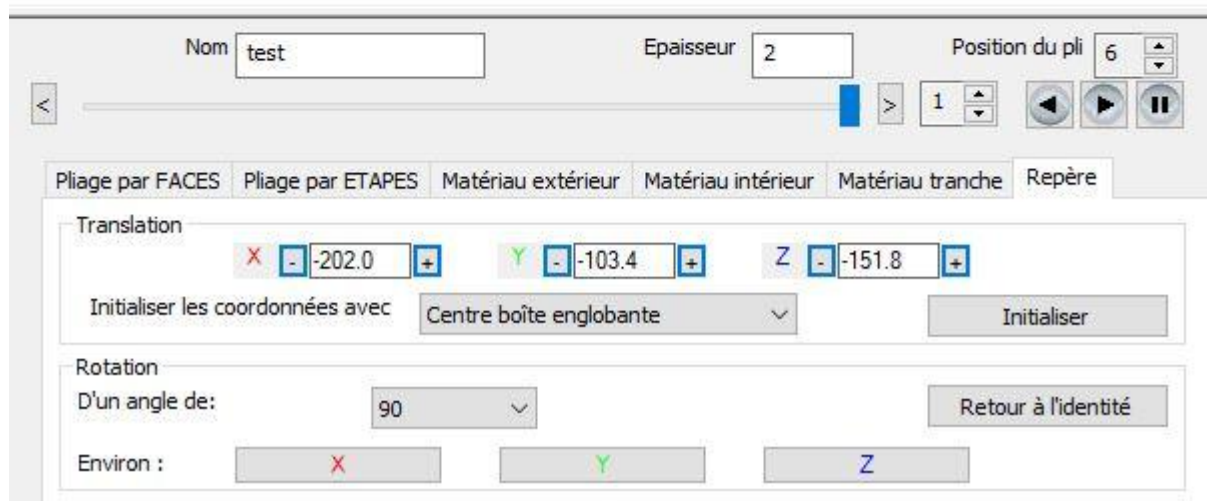
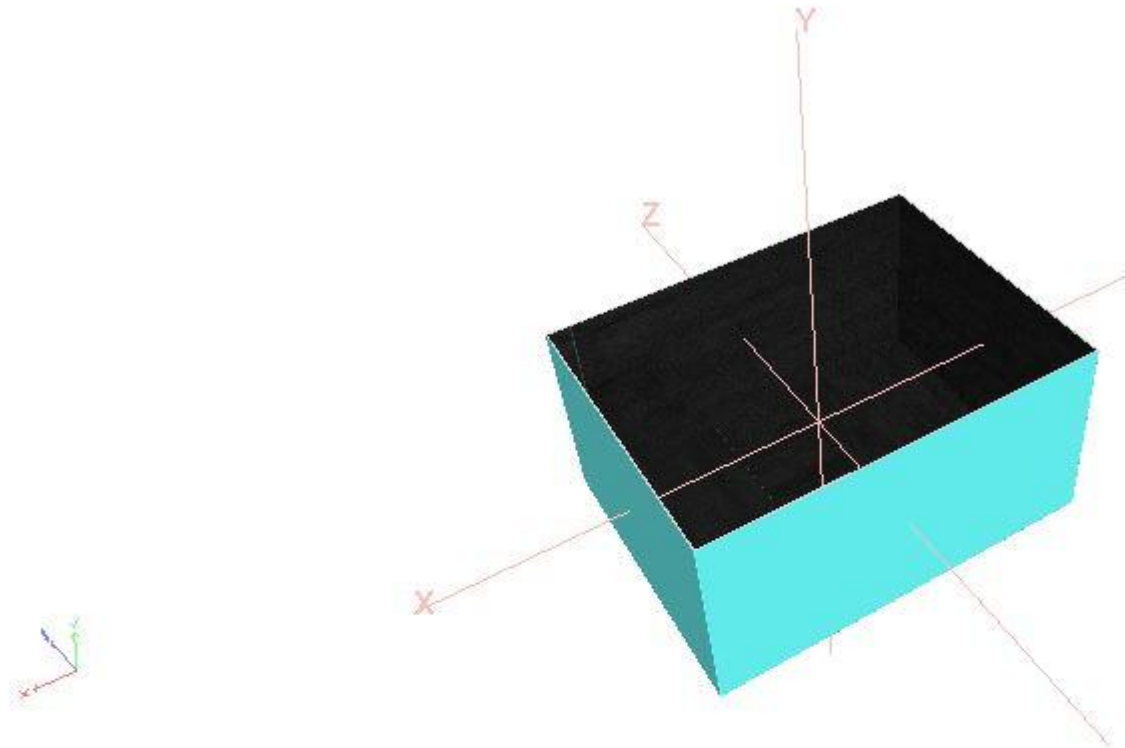

In the assembly window the markers of each object will be placed at the same point in order to create a global coordinate system.

Others 3D objects

Create a 3D object by revolution

To create a revolution solid, you have to define a contour in PICador 2D.
 Draw the contour in the positive quarter plane ($x > 0, y > 0$), axis Y being the axis of revolution.

You just need then, after transfer it in PIC3D

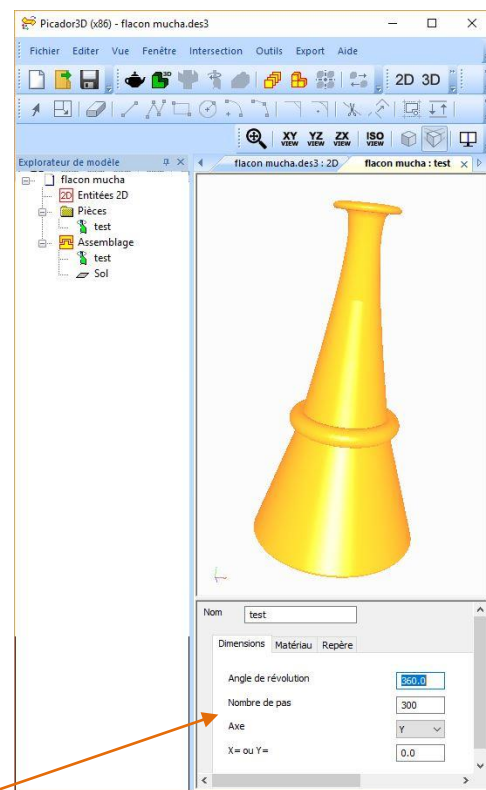
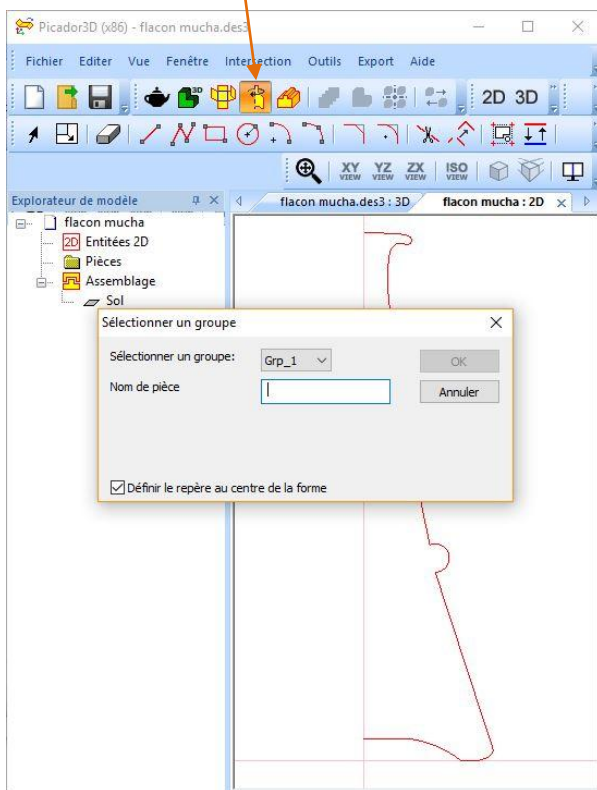
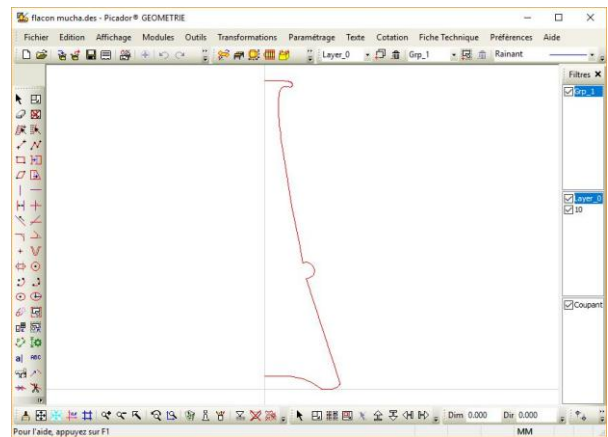



- Angle of revolution: Sets the angle of revolution of the shape.
- Number of steps: Defines the quality of the rendering of the revolution
- Axis: the axis of the revolution
- X = or Y = Position the piece resulting from the revolution

Create a 3D object by extrusion

To create an extruded solid type, you have to define a contour in PICador 2D. Direction of extrusion is orthogonal to the screen.

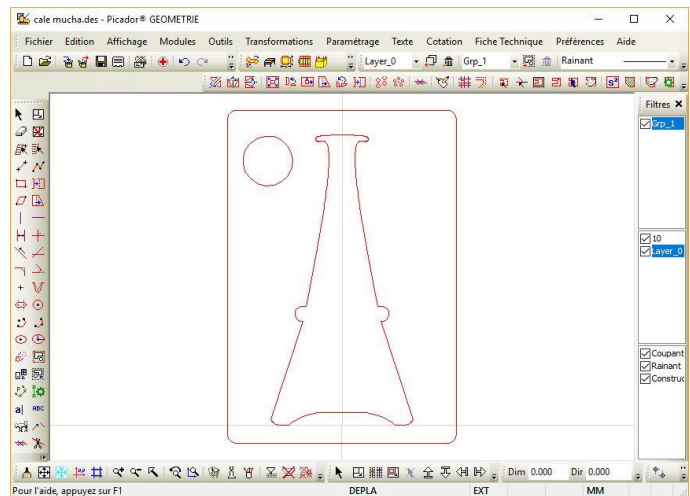
You can then load the file in PIC 3D and create an extruded solid using tool **"Create new solid by extrusion"**.



You need then, after transfer in PIC3D  to create a solid by extrusion using the icon and giving the height of extrusion .

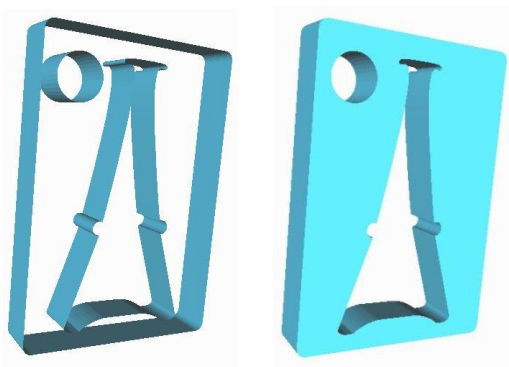
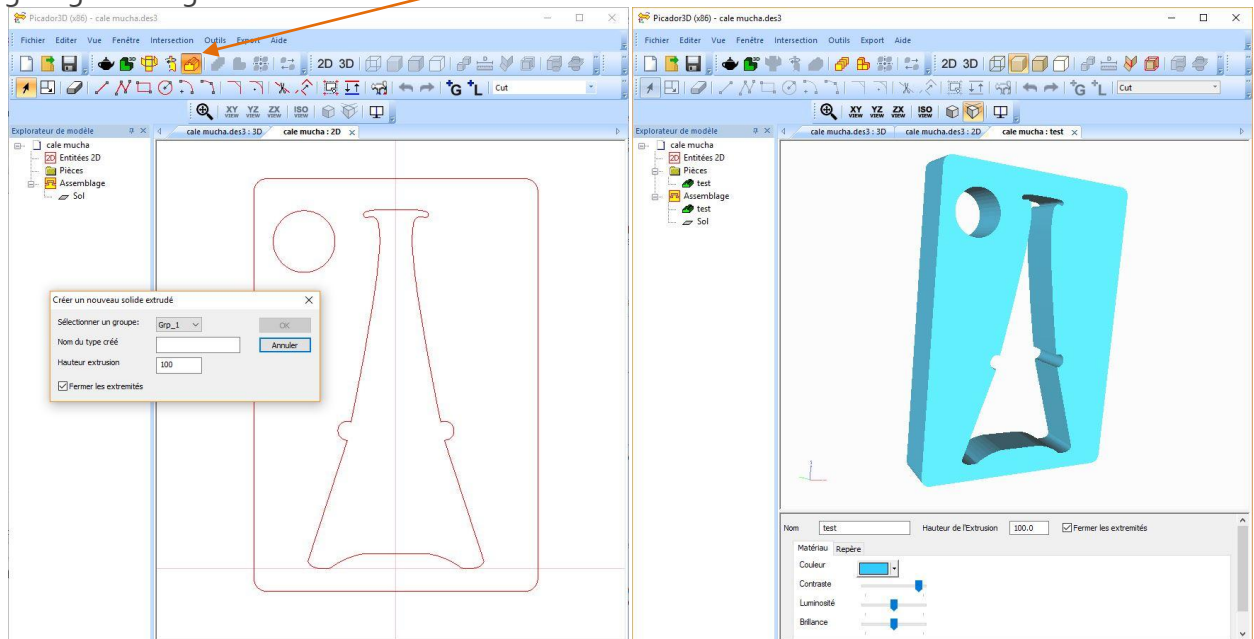

The option **Close the extremities** allows you to create only the extrusion for the contour or create a block.

Import a 3D object

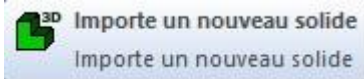

Importe un nouveau solide
Importe un nouveau solide

To import an existing 3D object, you need to use the icon, then with the navigator, giving a name of the 3d file to load..

The compatible files could be triangular files ((STL type (STereoLithography) or des fichiers CAO 3D (IGES, STEP).

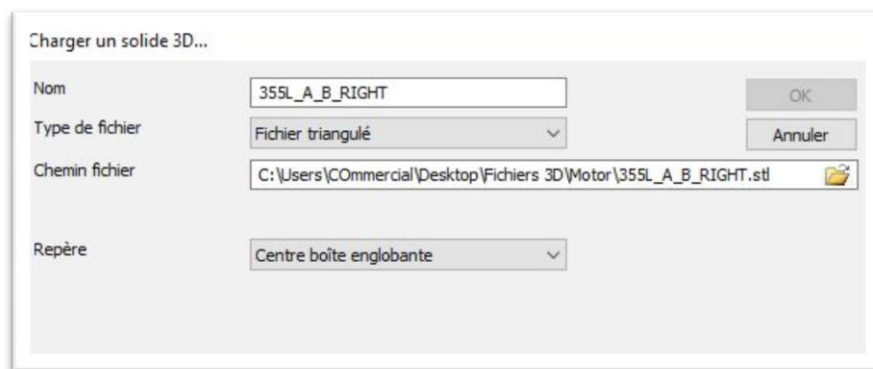

Import a new solid

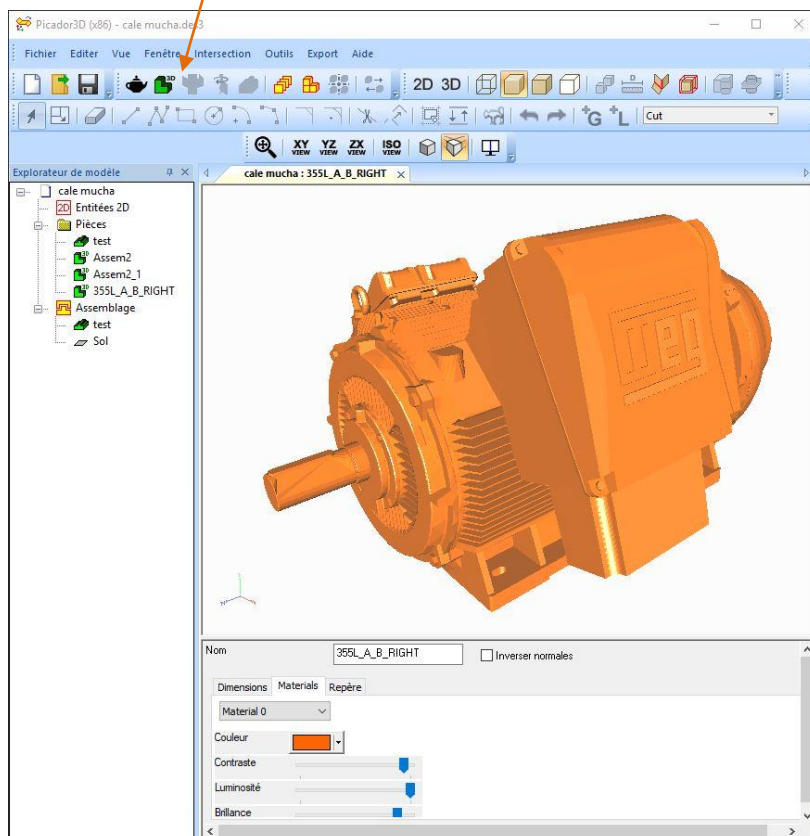

STL files are especially used for rapid prototyping and can be exported by most CAD softwares (SolidWorks™, Autocad™, SolidEdge™, Catia™, ...).

Create a composit 3D object

It's possible to create composit assembled solids in 3D from different 3D modules.
(Imported solid / Foldable solid / Revolution / Extrusion)

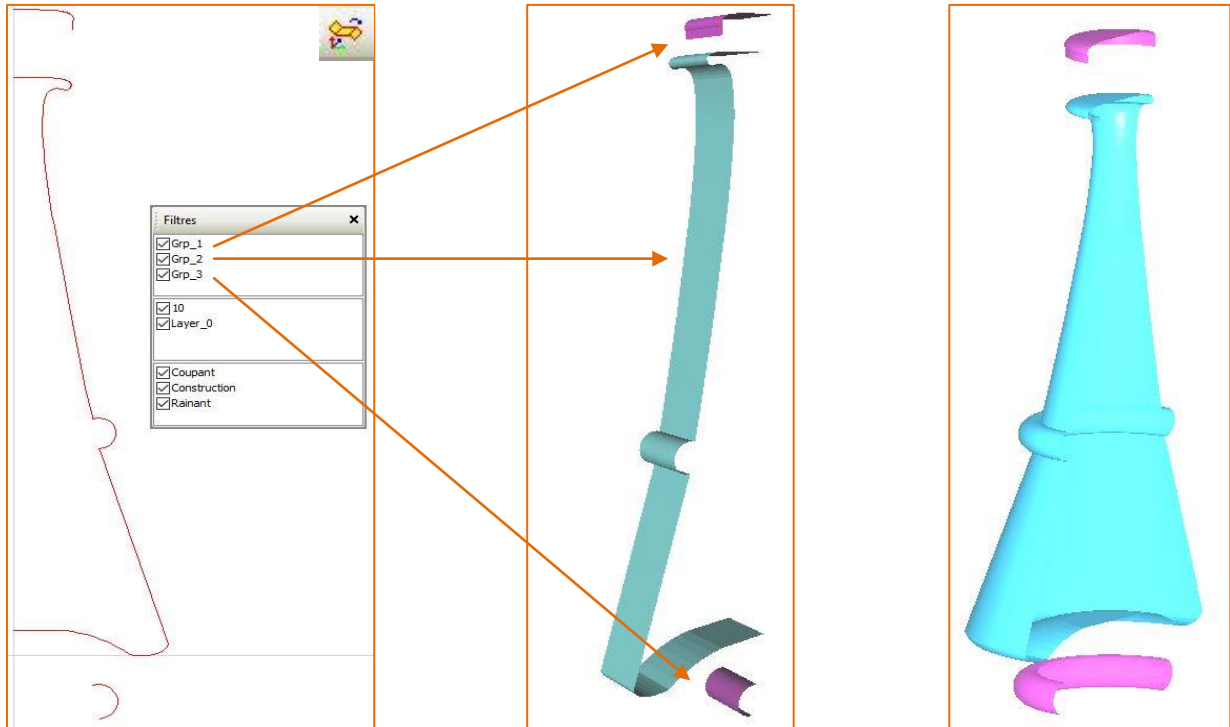

Composite solid elements: Create the composite solid elements in a single 2D PIC file, and then place each element in a different group.

3D extrusion: Select each element and perform 3D extrusion

3D revolution: Select each element and perform the 3D revolution

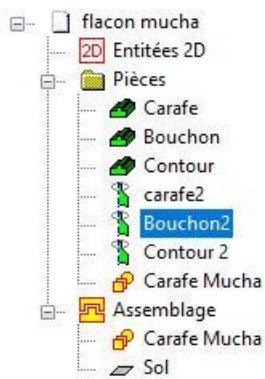

To dissociate the composite object, the function

Séparer les solides répétés/composés

Séparer les solides répétés/composés

allows you to recover each element separately again.



Once the elements are in 3D, it is now necessary to make an assembly by dragging each element in the "**assembly**" tab of the tree structure then position the different elements between them in order to constitute our composite solid

Drag the parts into the "**Assembly**" tab and proceed to assembly.

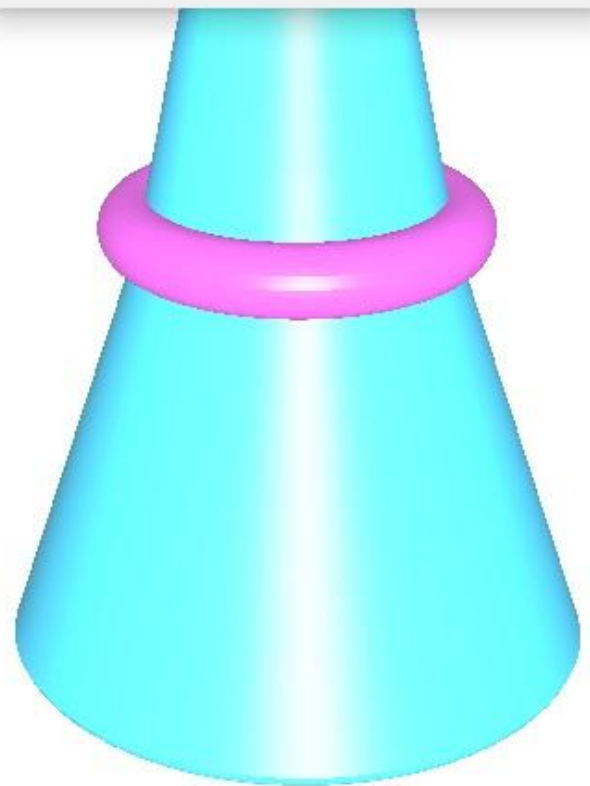

Create a repeated 3D object

 **Objets Répétés**
Créer une répétition d'objets

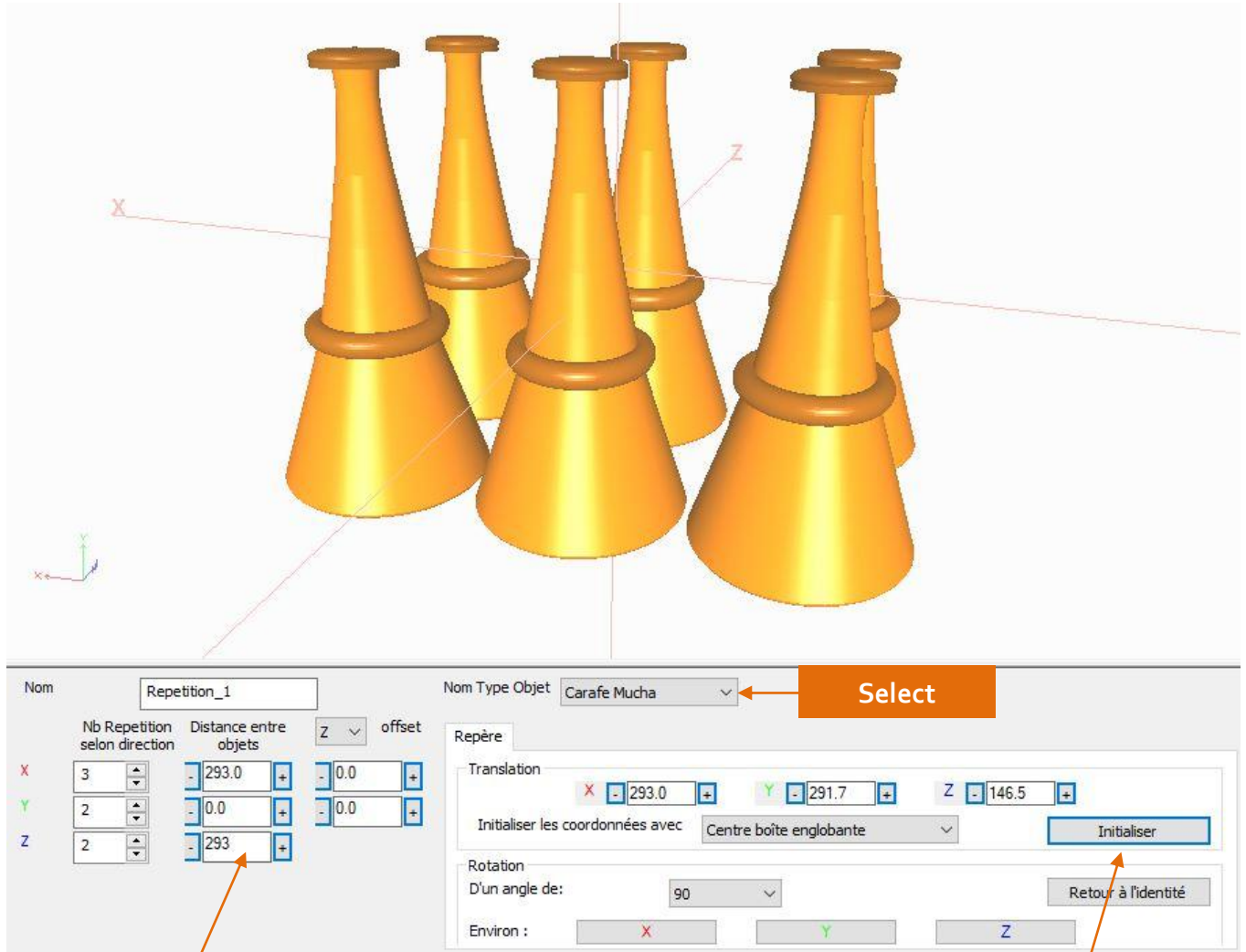

Enter the number of repetitions you want according to his direction (X ; Y ; Z) and also the distance solid to solid.

Select the solid to repeat, you can modify his coordinates and also the origin of the landmark.

3D ASSEMBLY

Principles of 3D assembly

The assembly is realized in the window « **Assembly** », adding the 3D pieces we had create or import.

Adding types of objects in the 3D view

Once created and imported, the types of 3D objects (solid, foldable, revolution, extrusion, imported 3D object) can be placed in the 3D view thanks to the file tree.

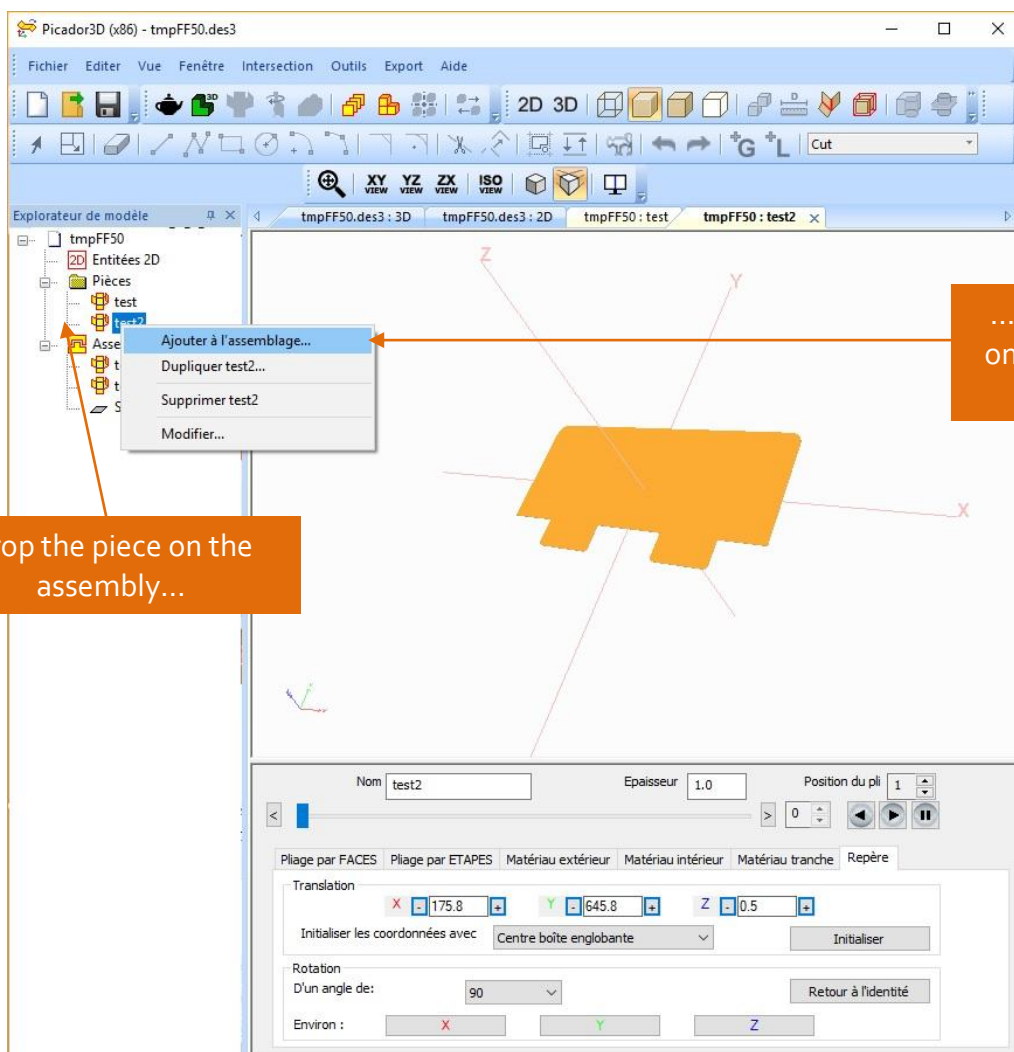

You can transfer a part to the assembly by right-clicking on the part in the tree files on the left, then selecting the "add to assembly" option. Or by clicking and dragging the part on the assembly folder, still in the tree files. When creating a package or a POS with several pieces, there are two solutions to assemble the pieces with **PIC3D**:

1st solution : Make only one 2D document grouping every piece on the same PICador 2D plan.

2nd solution : Make as many 2D documents and then 3D as pieces.

Then transfer the objects from a document to another one.

Transferency of solids between 2 documents



The assembly by transfer allows you to define the folding and the animation of each piece separately and then reuse it in each project where it is necessary.

1. Open document 1 (box)

2. Open document 2 (top)

3. Open a new document (Pic3D1)

4. Transferency of objects from a document to another one

5. Transferency of objects from a document to another one :
 box → Pic3D1
 top → Pic3D1

Once all the types of objects loaded in the 3D view, they can be used as many times as desired in the 3D scene with different positions and motion animations.

Global landmark –local landmark

The global landmark in the assembly view correspond to $x=0, y=0, z=0, R_x=0, R_y=0, R_z=0$. When an object of a given type is inserted in the assembly view, the local landmark position is set to the origin. The local landmark of each solid should be positioned for each animation step.

To display local landmarks use function 'Show solid trihedrons'

For each solid, the local landmark can be define in the landmark window.

Position of the landmark on the piece. Move on X Y Z

Orientation of the landmarks on the piece Rotating around X Y Z

Initialize the landmark with specific coordinates
Ex : volume center

So the foldable object type « top » in his local landmark

And the foldable object type « box » in his local landmark

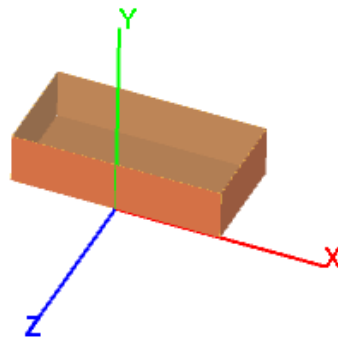
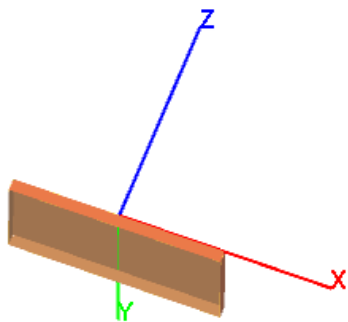

After insertion of the 2 solids in the 3D view :

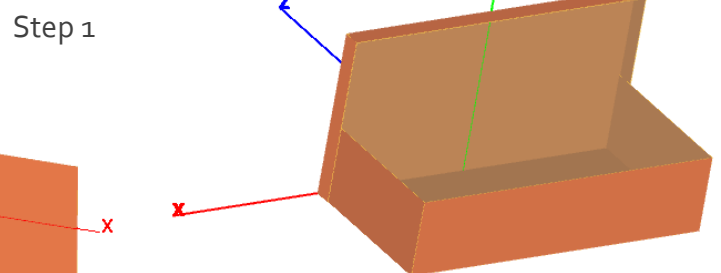
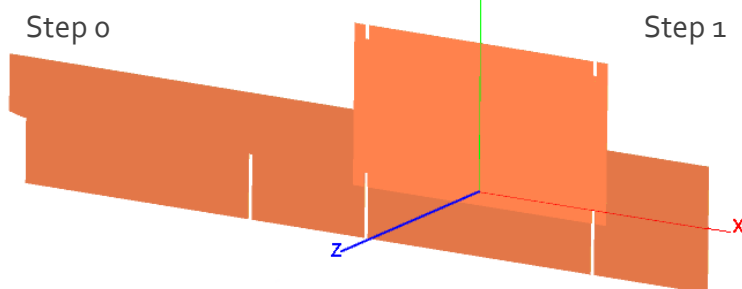

Moving the objects in the 3D assembly :

To select an object in the assembly, click on it in the tree files, or double-click on it in the 3D window. When an object is selected, it is possible to apply a displacement along the axis X Y Z: by changing the coordinates of its marker, or by moving the marker in the 3D view. The same system applies to apply a rotation of the object.

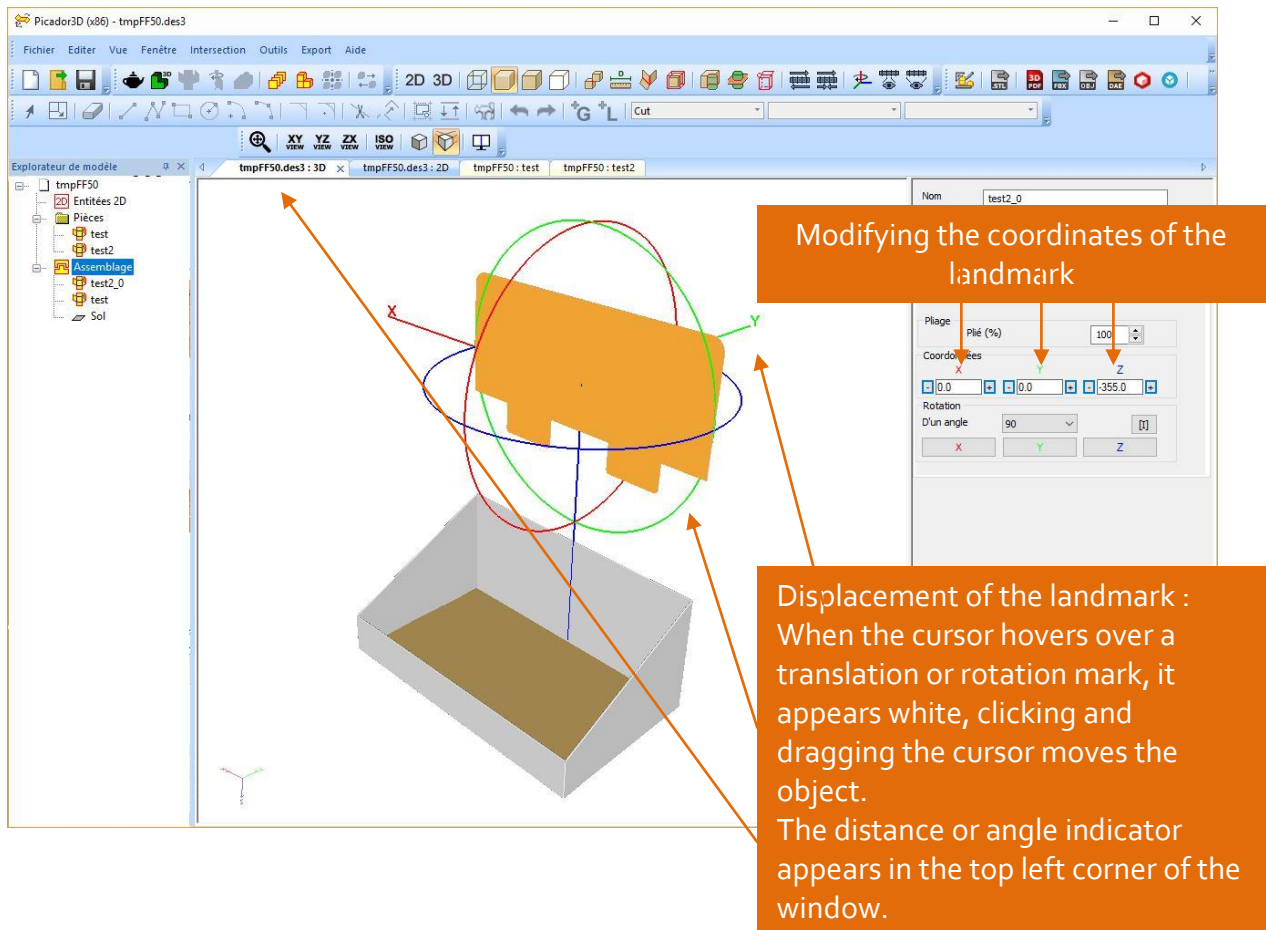

The assembly is divided into several stages. The position of each object is given for a specific step 0, 1

Displacement point-to-point

The function  allows you to modify the position of an object by double-clicking a point on the object, and then double-clicking a point on another object.

ANIMATION 3D

Principles of 3D animation

3D animation of objects is defined by the position of each object at each stage of the assembly. For each new step of the animation scenario, the user must define the position of each object. To realize the graphic animation the system will calculate for each step the trajectory of each object to reach the next step.

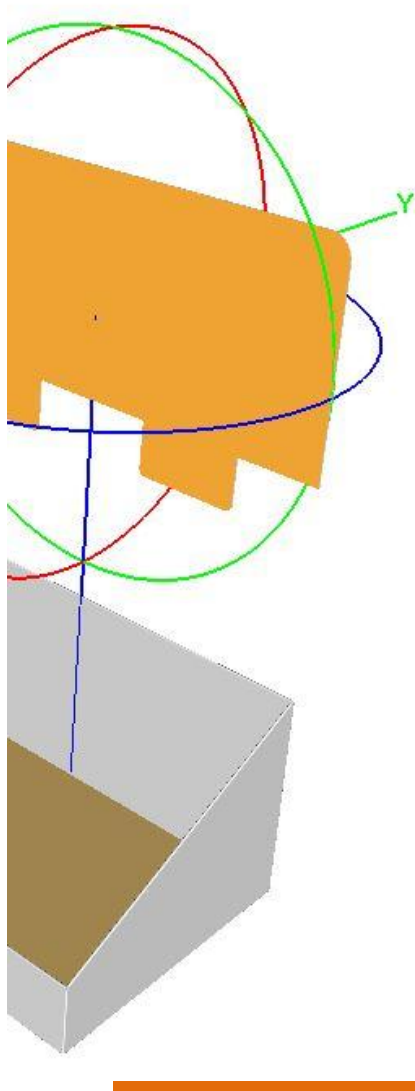

Move from a step to another

Nom		test2_0
		(test2)

Propriété générales		Déplacements
Visible	<input type="checkbox"/>	Larg.: 351.5
		Haut.: 4.3
Attacher...		Prof.: 187.5
Pliage		
Plié (%)		100
Coordonnées		
X	Y	Z
<input type="text" value="0.0"/>	<input type="text" value="0.0"/>	<input type="text" value="-355.0"/>
Rotation		
D'un angle	90	[]
X	Y	Z

STEP MANAGEMENT

Active step number

Etapes	
Etape courante	<input type="text" value="0"/>
Insérer une étape	Supprimer une étape

Répétition

Add a step after the active step

The cursor allows you to scroll all the steps of the animation

Folding management in 3D animation

In each step of the assembly, it is necessary to define the position of each object but also its folding.

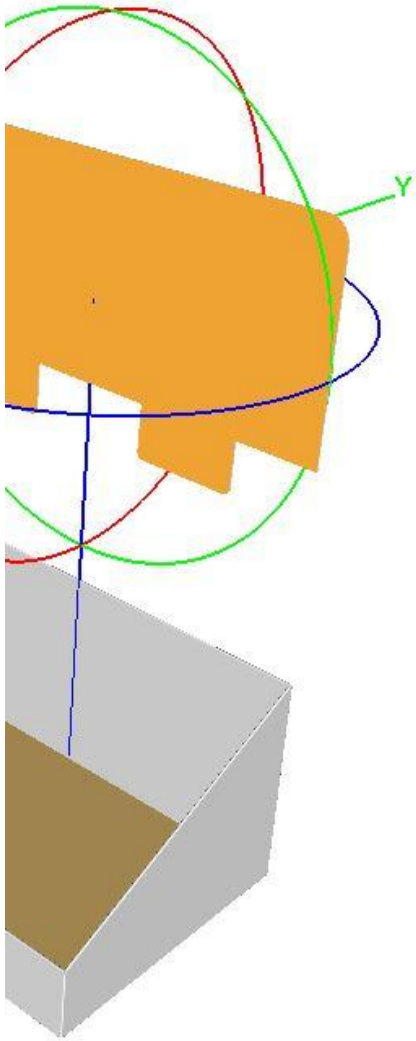

Nom
(test2)

Propriété générales **Déplacements**

Visible Larg.: 351.5
Haut.: 4.3
Prof.: 187.5

Attacher...

Piage
Plié (%)

Coordonnées
X Y Z

Rotation
D'un angle 90
X Y Z

Folding modification by step

Etapes
Etape courante
Insérer une étape Supprimer une étape

Répétition



Export 2D

Export a picture



The **Export Image** function allows to obtain as a bitmap file the current view without the background or the orientation trihedron.

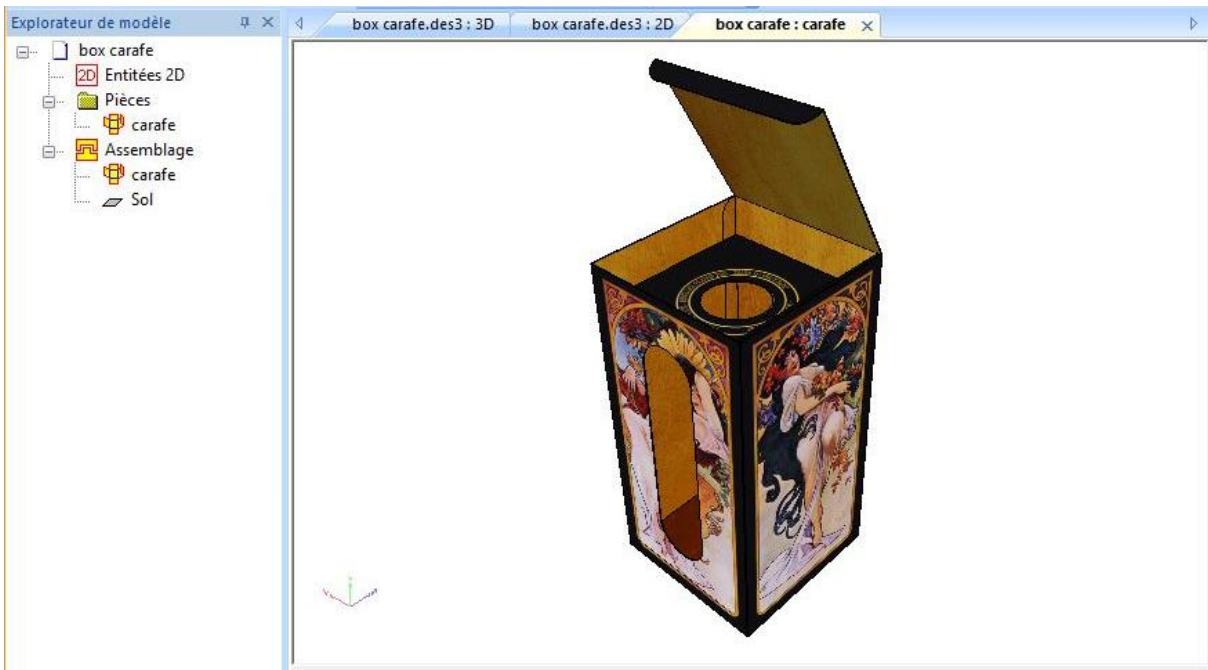

Export to the clipboard

The function « **Copy** »  allows you to capture the picture of the current view without the background and the trihedron to copy it (Ctrl V) in another application.

Copy  in Picador 3D

Copy (Ctrl+V) in another application (Word, Illustrator, Photoshop, ...)

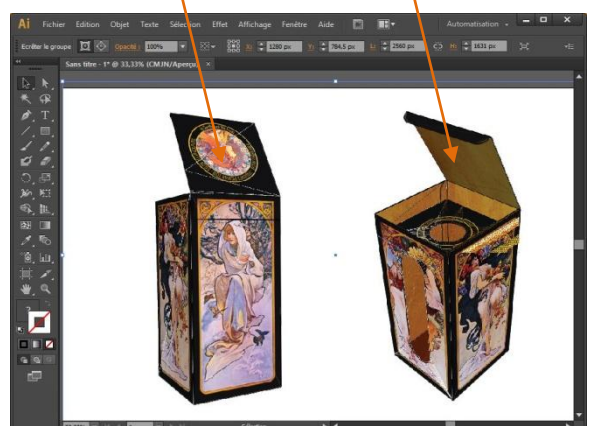
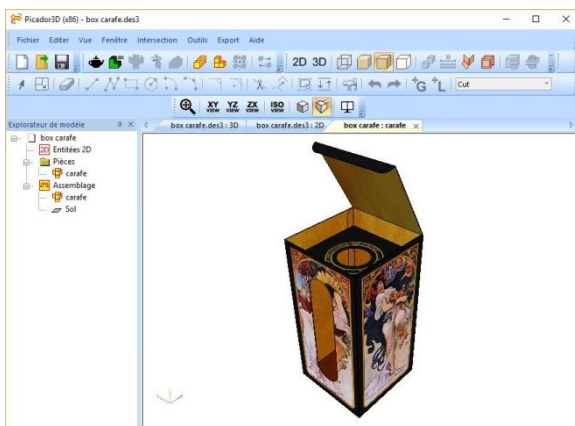

Obtaining a projected wireframed view (2D)



The **Projected Wired View** feature allows you to obtain the wireframe of the current view projected in the screen plane. This wired (vector) 2D view can then be retrieved in any vector drawing application (Picador, Autocad, Illustrator, Corel Draw, ...) for example.

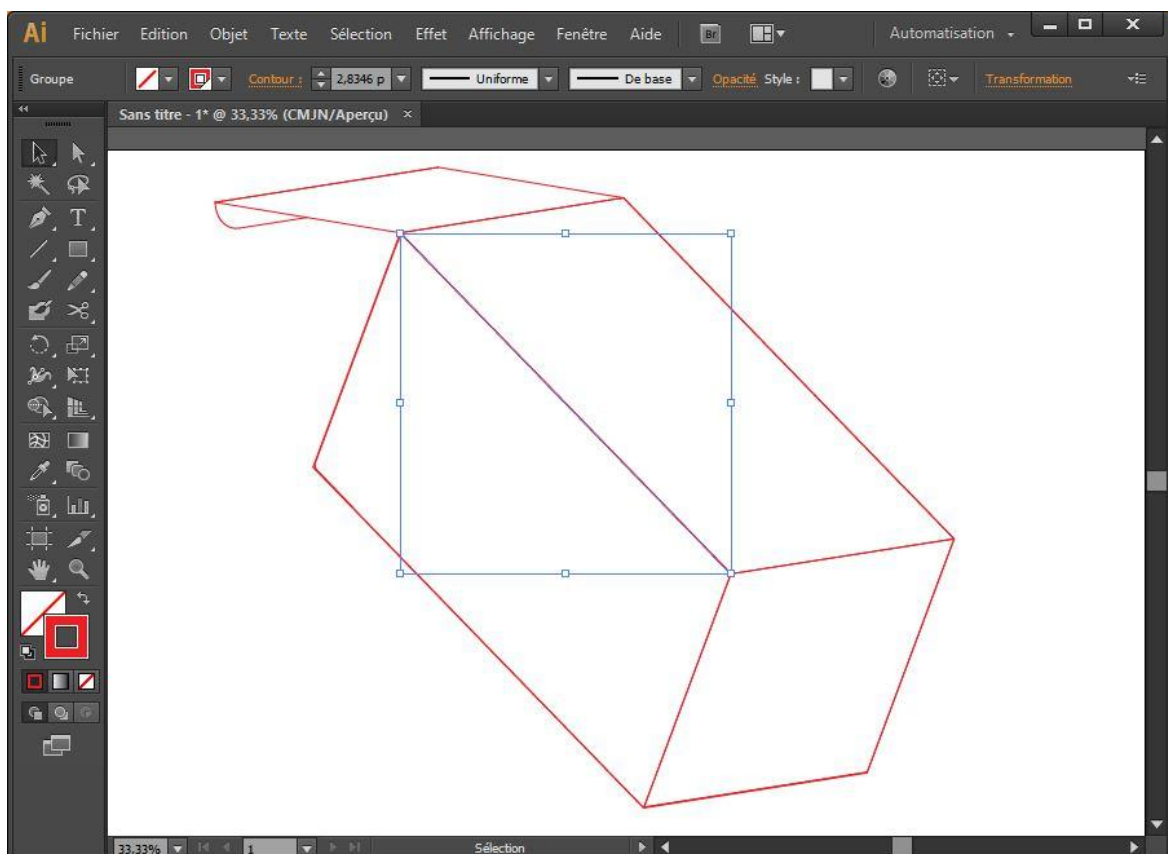
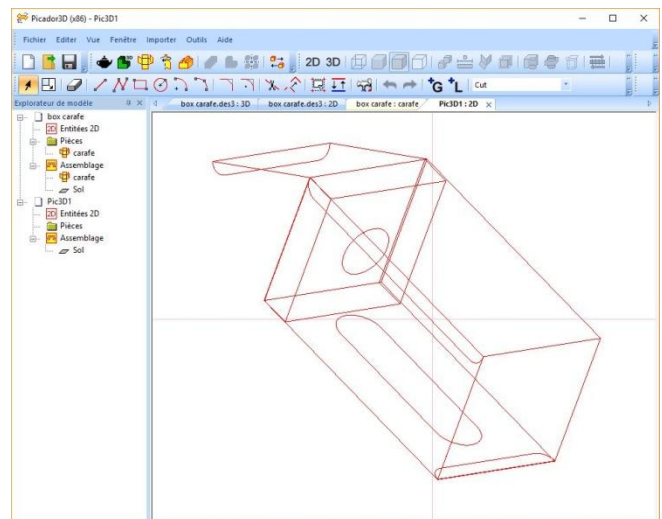
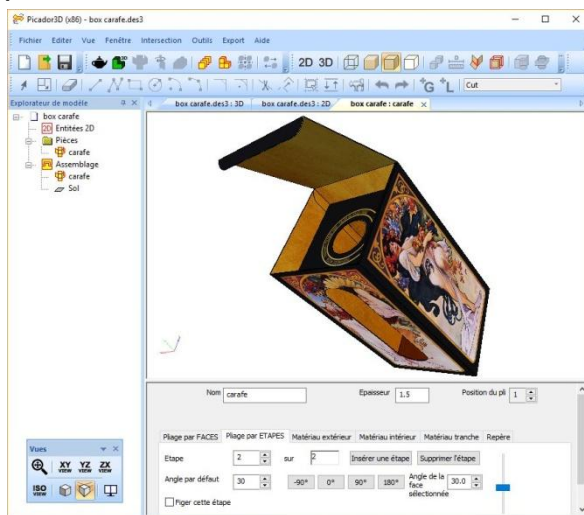

Export 3D objects

Export a 3D pdf



A pdf3D document can be generated from the view of each part, or from the assembly view, depending on the staging of your animation.

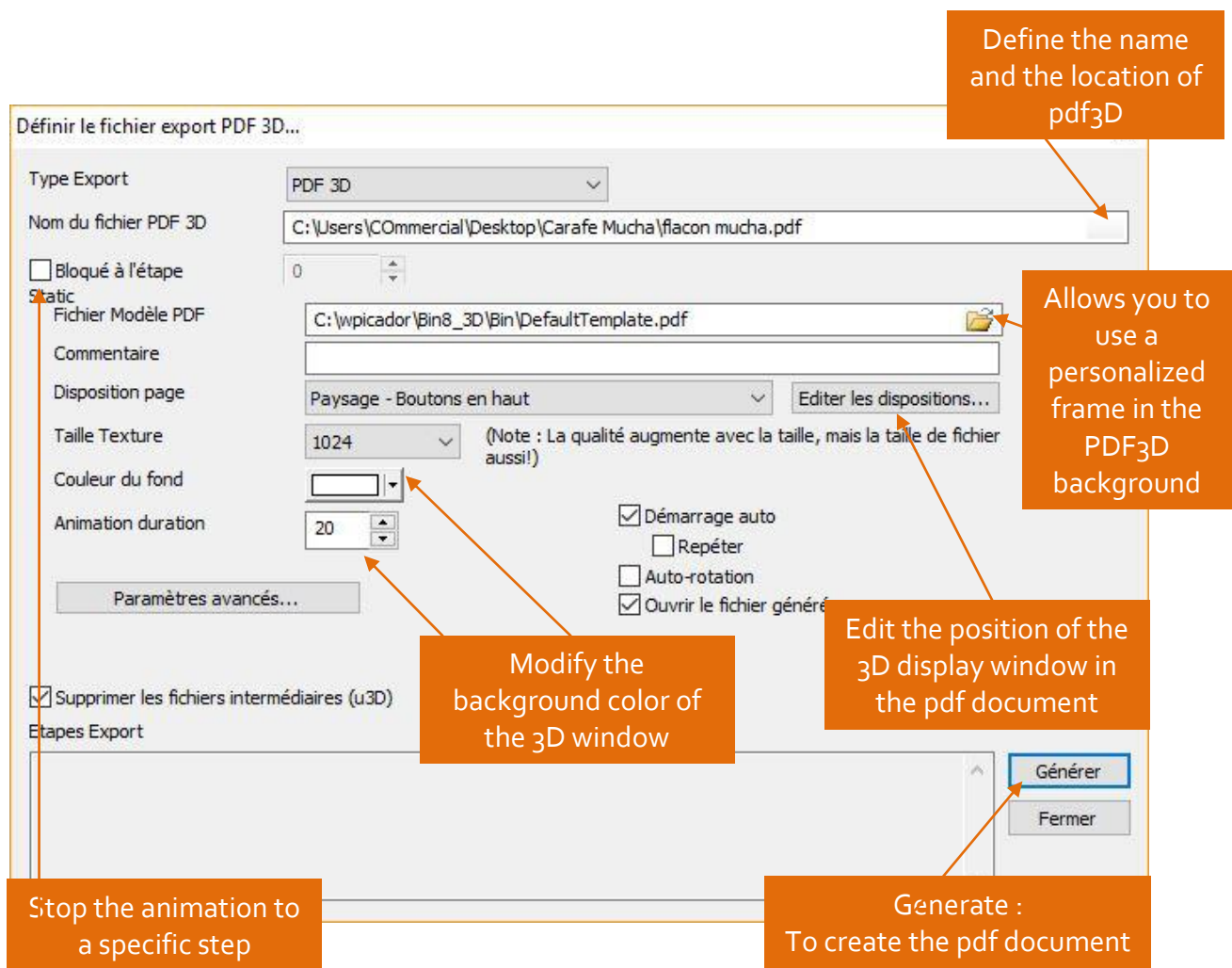

The screenshot shows the 'Définir le fichier export PDF 3D...' dialog box with the following settings and annotations:

- Type Export:** PDF 3D (Annotated: Define the name and the location of pdf3D)
- Nom du fichier PDF 3D:** C:\Users\COMmercial\Desktop\Carafe Mucha\flacon mucha.pdf
- Bloqué à l'étape:** 0 (Annotated: Stop the animation to a specific step)
- Fichier Modèle PDF:** C:\wpcador\Bin8_3D\Bin\DefaultTemplate.pdf (Annotated: Allows you to use a personalized frame in the PDF3D background)
- Disposition page:** Paysage - Boutons en haut (Annotated: Edit the position of the 3D display window in the pdf document)
- Taille Texture:** 1024 (Note : La qualité augmente avec la taille, mais la taille de fichier aussi!)
- Couleur du fond:** (Annotated: Modify the background color of the 3D window)
- Animation duration:** 20
- Options:**
 - Démarrage auto
 - Répéter
 - Auto-rotation
 - Ouvrir le fichier généré
- Buttons:** Paramètres avancés..., Générer, Fermer (Annotated: Generate : To create the pdf document)
- Supprimer les fichiers intermédiaires (u3D):**
- Etapes Export:** (Empty list)

A pdf3D makes it possible to move the piece in 3D and to make it a 3D interactive cinematic reading (requires Adobe™ Reader free version 9.x or later).
3D generated pdf:

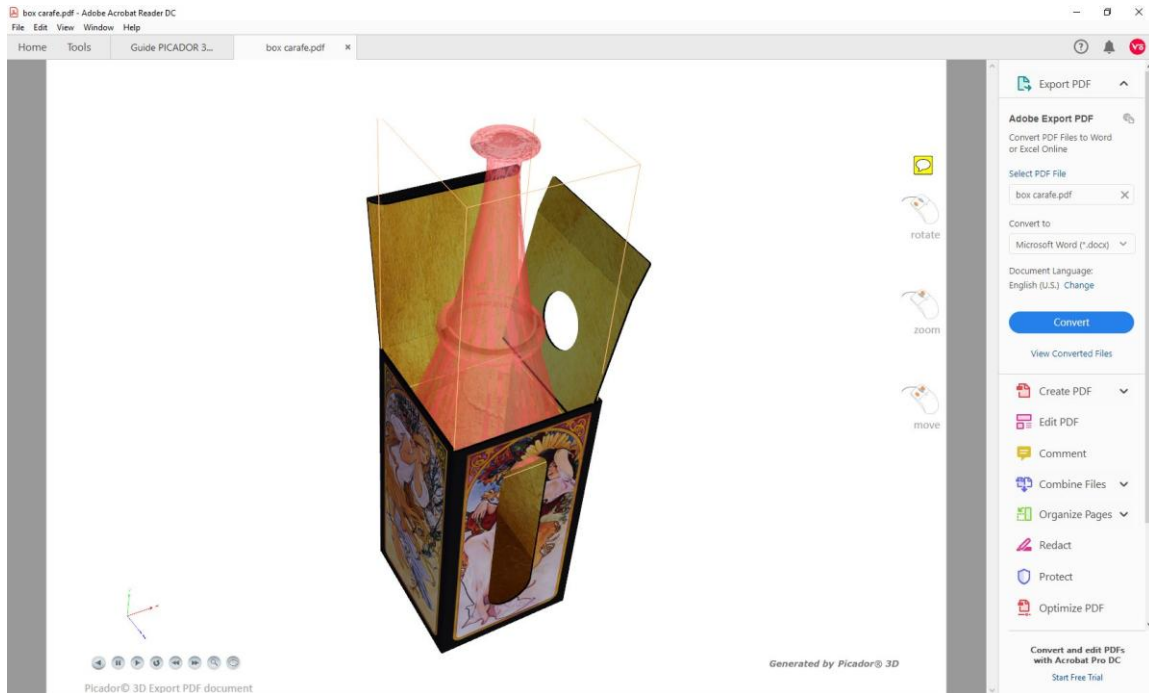

Forward | Pause | Play | Repeated play | Slow | Accelerate | Repositioning | Rotating

Export a video capture



The various elements present in the assembly can also be exported in video .avi or .wmp according to the staging of your animation.

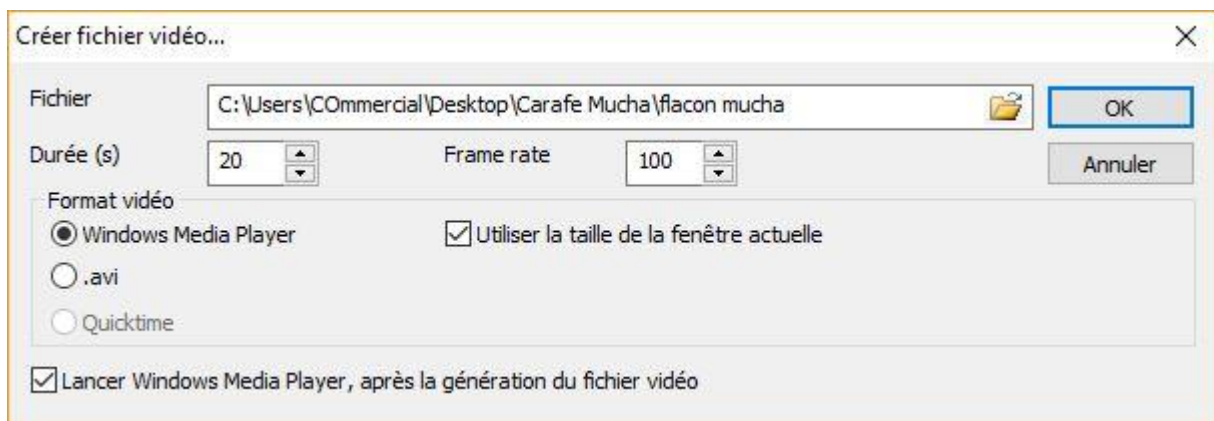

Export Collada .DAE et .FBX



With 3D export functions, you can create complex, single or complex objects for other 3D applications.

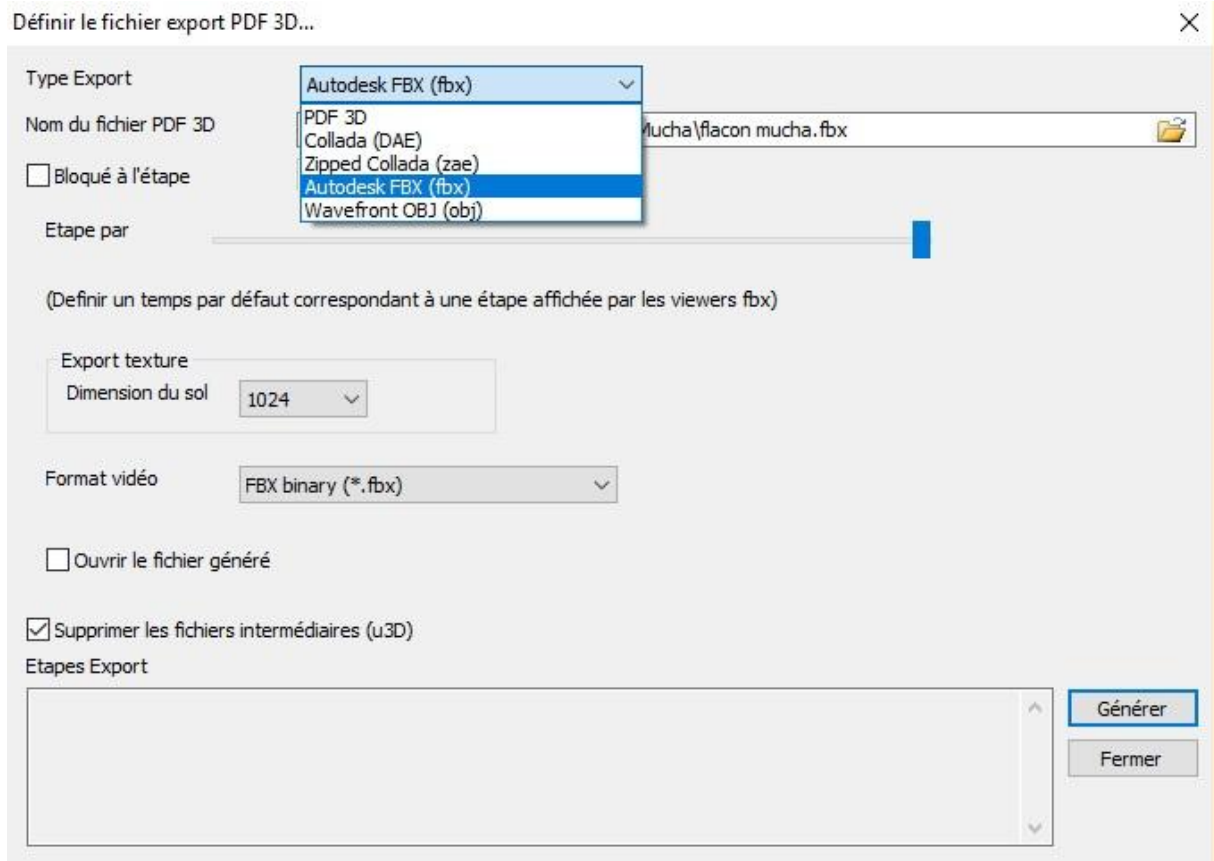

Export .STL



It is also possible to create complex assemblies or simple objects for other 3D applications in .stl format.

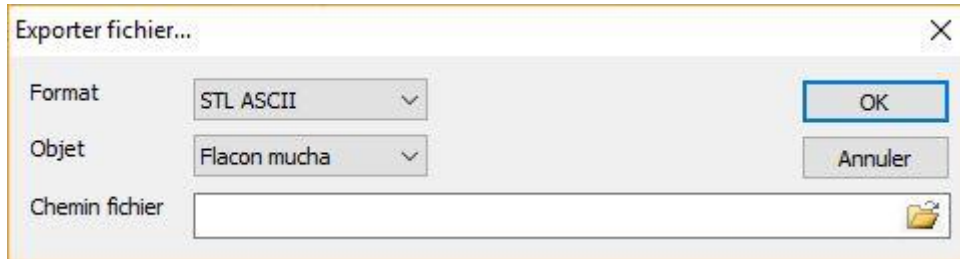

The solid composite function allows you to link fixed 3D elements together. Coupled with the 3D export function, you can create complex assemblies or simple objects for other 3D applications (.stl format).

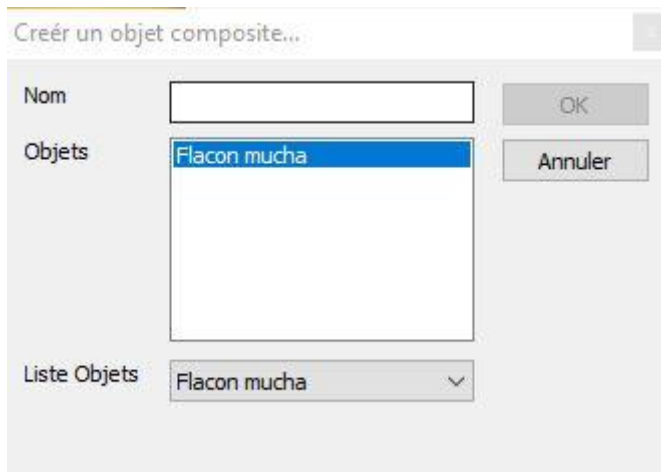

Export virtual reality



Connect on www.augment.com to use this fonctionality.
The created model is directly uploaded on your Augment account.

Télécharger vers Augment...
✕

Identifiant	<input type="text" value="picador3d"/>	Mot de passe	<input type="password" value="••••••"/>
Titre (*)	<input type="text" value="flacon mucha"/>		
Description	<input type="text" value="(Generated by Picador3D)"/>		
Mots clés	<input type="text"/>		
Lien internet	<input type="text" value="www.treedim.com"/>		

Ouvrir la page du modèle sur le site web Augment

Bloqué à l'étape ▲ ▼

(*) = champs obligatoires

3D INTERSECTION

Principles of 3D intersection



The foldable solid / solid intersection function makes it possible to obtain the cutting of a fold relative to its intersection with a 3D object.

The intersection is calculated with respect to the displayed folding step.

Intersection contours are defined in the group chosen by the user.

In the 2D view, the set of intersection cuts in the unfolded view is retrieved..

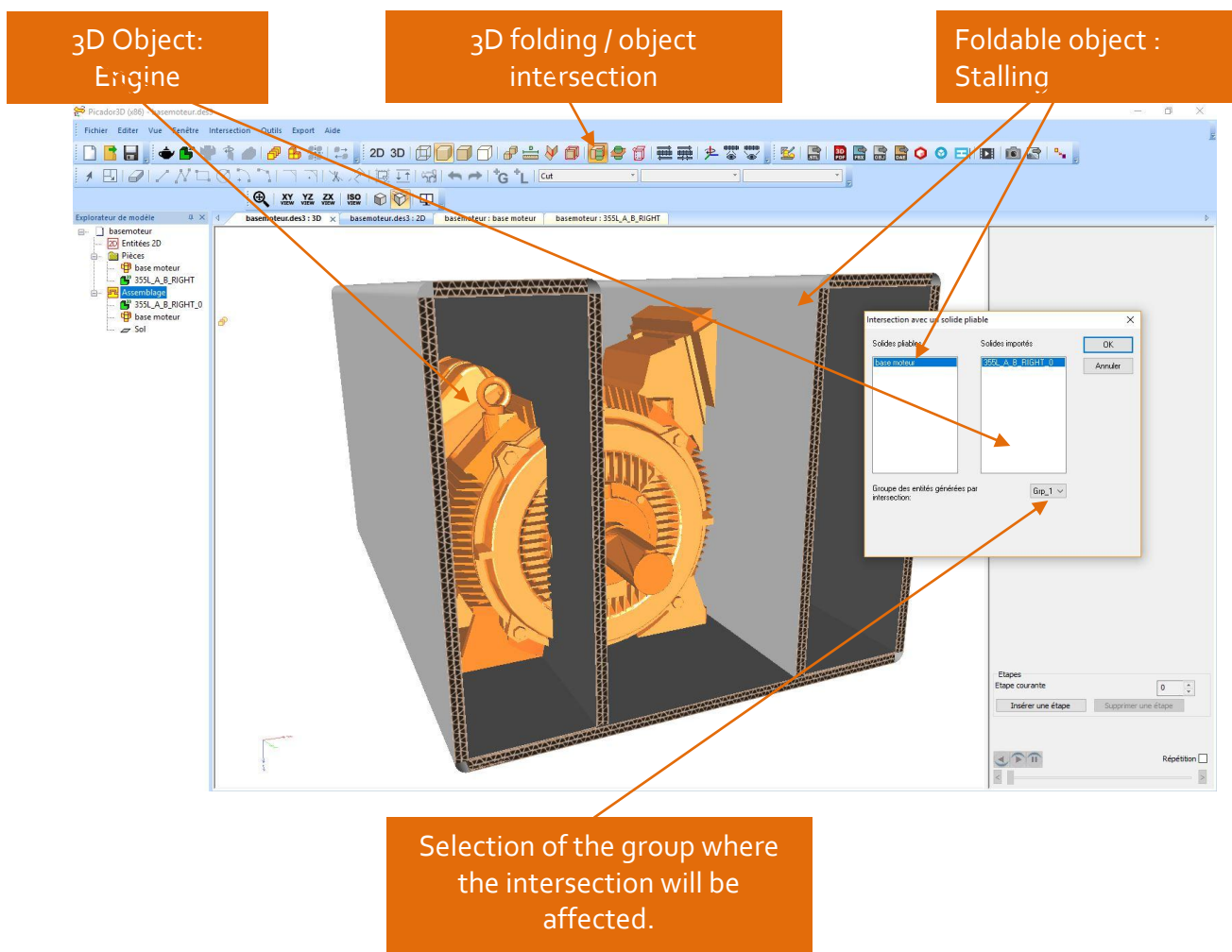



Intersection calculation example

Import a foldable solid and a 3D object

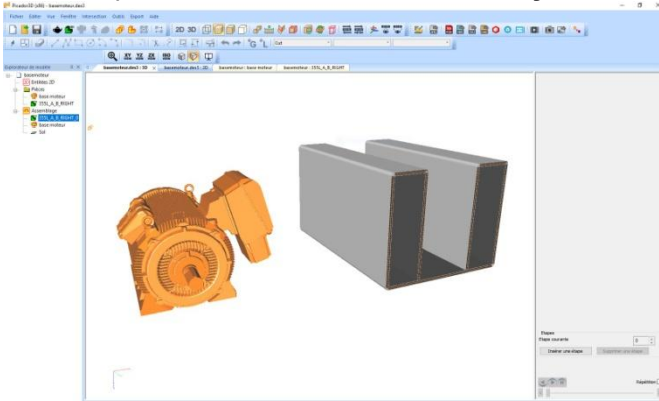

Assembling

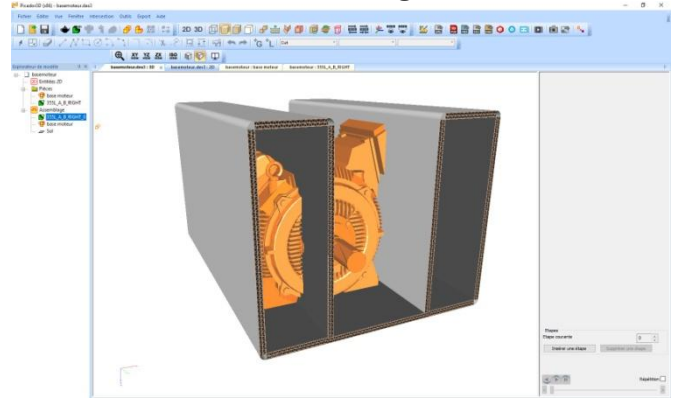

Intersection calculation

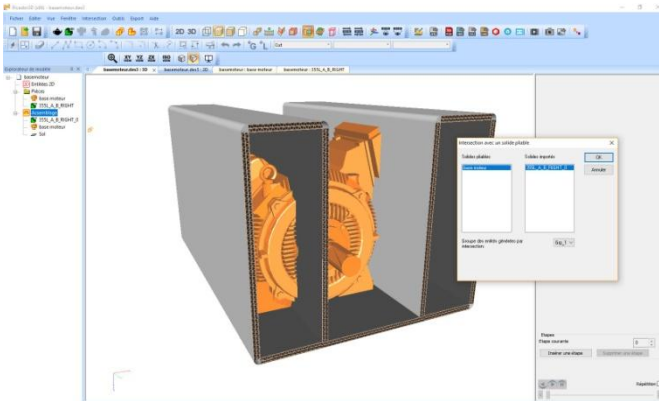

Intersection result

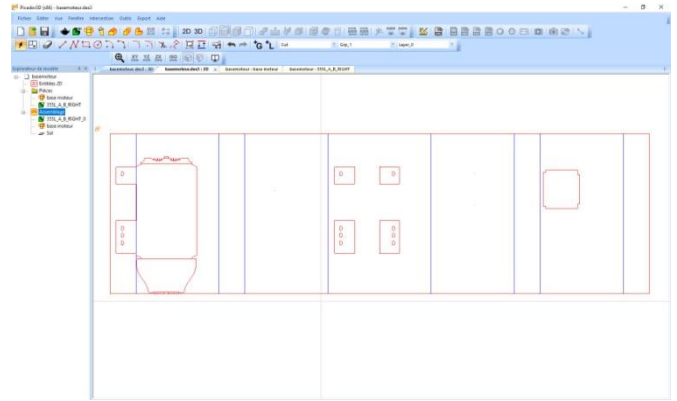

Folding of the cutting shape

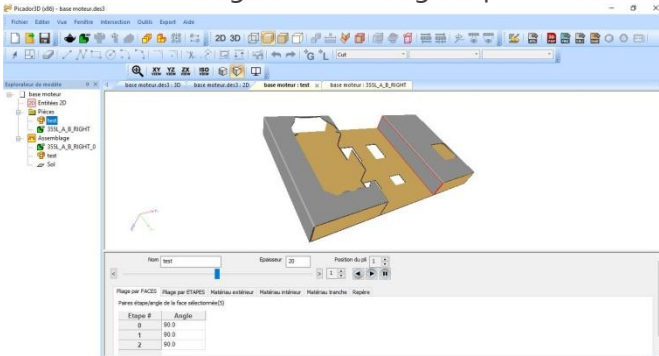

Re-assembling of 3D object

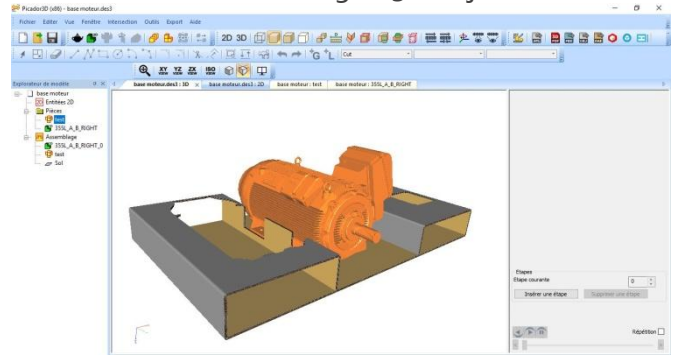



3D dimension

3D dimension creation

The **3D Dimensioning feature** allows you to display a dynamic dimension by selecting two points (double-click) in the assembly. Then select a third point to place the rating.

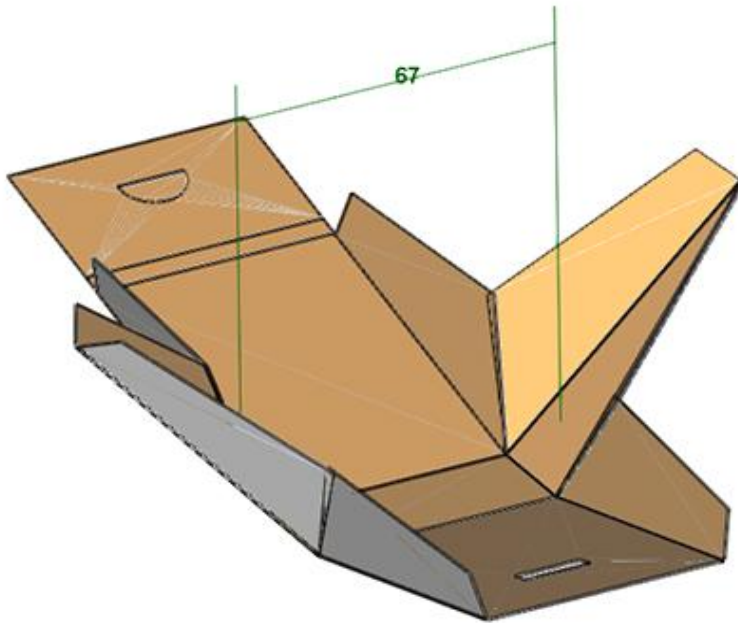

3D dimensions editing

The dimensions can be edited selecting in the tree files, or in the 3D view.

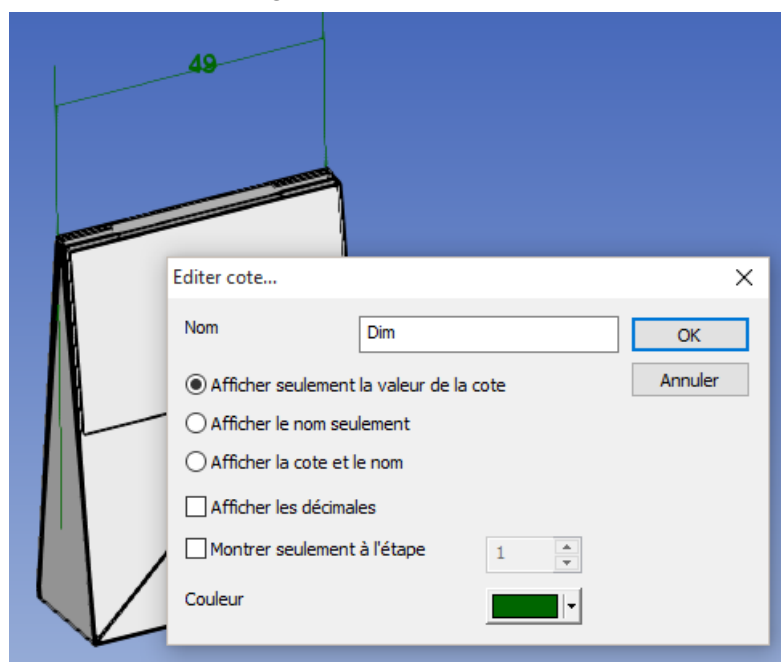

Merci de votre attention

Nous vous souhaitons une bonne utilisation de PIC3D

PIC3d.©

